

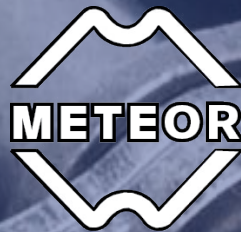

METEOR Kettenfabrik GmbH

www.meteor-ketten.com



Deutsche Qualität seit 1892



METEOR KETTENFABRIK GMBH

METEOR Kettenfabrik GmbH als Nachfolger eines im Jahre 1892 gegründeten Unternehmens setzt die Tradition anerkannter unter Warenzeichen Pallas-Werke und später KEBA deutscher Stahl- und Metallbearbeitung fort.

Seit über 40 Jahren ist der Betrieb auf die Entwicklung und Produktion von Rollenketten für verschiedenste Zweige der Industrie, der Bauwirtschaft und der Landwirtschaft spezialisiert. Die Produkte der METEOR Kettenfabrik mit dem Markenzeichen METEOR überzeugen durch hochwertige Qualität und funktionelle Präzision in Deutschland und weltweit in ganz unterschiedlichen Einsatzgebieten.

Jahrzehntelange Erfahrungen und ausgezeichnetes Fachpersonal in allen Bereichen des Unternehmens bilden die Grundlage für Qualität, Effektivität und Solidität. Ein eigener Werkzeugbau und ein mit modernster und neuester Technik ausgestatteter Maschinenpark ermöglichen dem Unternehmen den unterschiedlichsten Marktansforderungen gerecht zu werden.

Die METEOR Kettenfabrik als kundenorientiertes Unternehmen

- verbindet Tradition, Innovation und Zukunftsbewusstsein
- steht für hohe Qualität, Fairness im Preis- und Leistungsverhältnis, Liefer- und Termintreue

As the successor of the enterprise established in 1892, METEOR Kettenfabrik Ltd. keeps on following traditions of German steel and metal processing well known under such trade names as KEBA and later as Pallas-Werke.

For over 40 years, the company specializes in design and production of roller chains for diverse sectors such as industrial field, construction and agriculture. The products of METEOR Kettenfabrik Ltd. under the trademark METEOR stand out due to their high quality and functional accuracy in operation covering a wide range of applications on national and global levels.

The decades of expertise and excellent professional personnel in all performance areas of the company form the basis for quality, efficiency and integrity. Tool making and machine shops equipped with state-of-the-art technologies boost the company to meet the varied market demands.

As customer-oriented enterprise METEOR Kettenfabrik

- *combines traditions, innovation and future prospects*
- *stands for high quality, fairness in price-performance ratio, compliance with production and delivery deadlines*



METEOR Kettenfabrik GmbH

Nürnberger Straße 2
36456 Barchfeld/Werra
Deutschland

Tel.: +49 (0)36961/69 04-0
Fax: +49 (0)36961/69 04-29

info@meteor-ketten.com
www.meteor-ketten.com

Ausführung

- Europäische Bauart
- Amerikanische Bauart
- METEOR-Norm

Eigenschaften

- kaltfließgepresste Rollen
- Kalott-Rollen
- gewickelte Rollen
- vorgereckt mit min. $\frac{1}{3}$ der Bruchkraft
- Laschen aus Vergütungsstahl
- Rollen, Buchsen, Bolzen aus Einsatzstahl

Oberfläche

- ungefettet - mit Werksfettung - Fettung nach Anwendung (hitze-/kältebest., Lebensmittelfett)
- galvanisch verzinkt/ blau chromatiert bis 16 B
- galvanisch vernickelt

Design

- European design
- American design
- METEOR factory standard

Characteristics

- cold extruded rollers
- calotte rollers
- lapped rollers
- pre-stretched with at least $\frac{1}{3}$ of breaking strength
- plates out from tempered steel
- rollers, bushes, pins out from hardened steel

Surface

- ungreased - factory lubrication - lubrication due to application conditions (heat/cold-resistant, foodstuff lubricating grease)
- galvanic zinc-plated/blue chromated up to 16 B
- galvanic nickel-plated



6

ROLLENKETTEN

ROLLER CHAINS



Ausführung

- Planlaschen schmal/breit
- Winkellaschen schmal/breit
- Zackenlaschen

Eigenschaften

- kaltfließgepresste Rollen
- Kalott-Rollen
- gewickelte Rollen
- vorgereckt mit min. $\frac{1}{3}$ der Bruchkraft
- Laschen aus Vergütungsstahl
- Rollen, Buchsen, Bolzen aus Einsatzstahl

Oberfläche

- ungefettet - mit Werksfettung - Fettung nach Anwendung (hitze-/kältebest., Lebensmittelfett)
- galvanisch verzinkt/ blau chromatiert bis 16 B
- galvanisch vernickelt

Design

- narrow /wide straight plates
- narrow /wide bent plates
- toothed plates

Characteristics

- cold extruded rollers
- calotte rollers
- lapped rollers
- pre-stretched with at least $\frac{1}{3}$ of breaking strength
- plates out from tempered steel
- rollers, bushes, pins out from hardened steel

Surface

- ungreased - factory lubrication - lubrication due to application conditions (heat/cold-resistant, foodstuff lubricating grease)
- galvanic zinc-plated/blue chromated up to 16 B
- galvanic nickel-plated



11

ROLLENKETTEN MIT SONDERLASCHEN

ROLLER CHAINS WITH SPECIAL PLATES

Ausführung

- 2-/3-fach Bolzen
- 2-/3-fach Verschlussbolzen
- anderes auf Anfrage

Eigenschaften

- kaltfließgepresste Rollen
- Kalott-Rollen
- gewickelte Rollen
- vorgereckt mit min. $\frac{1}{3}$ der Bruchkraft
- Laschen aus Vergütungsstahl
- Rollen, Buchsen, Bolzen aus Einsatzstahl

Oberfläche

- ungefettet - mit Werksfettung - Fettung nach Anwendung (hitze-/kältebest., Lebensmittelfett)
- galvanisch verzinkt/ blau chromatiert bis 16 B
- galvanisch vernickelt

Design

- single/double pins
- single/double connecting pins
- other design on request

Characteristics

- cold extruded rollers
- calotte rollers
- lapped rollers
- pre-stretched with at least $\frac{1}{3}$ of breaking strength
- plates out from tempered steel
- rollers, bushes, pins out from hardened steel

Surface

- ungreased - factory lubrication - lubrication due to application conditions (heat/cold-resistant, foodstuff lubricating grease)
- galvanic zinc-plated/blue chromated up to 16 B
- galvanic nickel-plated



14

ROLLENKETTEN MIT VERLÄNGERTEN BOLZEN

ROLLER CHAINS WITH EXTENDED PINS

Ausführung

- Grundkette ähnlich DIN 8188
- Teilung 1"
- Beläge in grau oder Schwarz
- NBR-Profil

Eigenschaften

- gute Beständigkeit gegen Fette, Öle und Kraftstoffe
- Härte +/-70 Shore

Oberfläche

- ungefettet - mit Werksfettung - Fettung nach Anwendung (hitze-/kältebest., Lebensmittelfett)

Design

- basic chain similar to DIN 8188
- pitch 1"
- coating in gray or black
- NBR profile

Characteristics

- great resistance against greases, oils and fuels
- hardness +/-70 Shore

Surface

- ungreased - factory lubrication - lubrication due to application conditions (heat/cold-resistant, foodstuff lubricating grease)



15

ROLLENKETTEN MIT U-BÜGELN MIT/OHNE GUMMIPROFIL

ROLLER CHAINS

WITH U-SHAPED BRACKETS

WITH/WITHOUT MOLDED RUBBER STRIP

18



FLYERKETTEN

LEAF CHAINS

Ausführung

- nach DIN 8152

Eigenschaften

- sehr hohe Bruchkraft
- hohe Kraftübertragung
- verschleißarm

Oberfläche

- mit Werksfettung bzw. leicht geölt

Design

- in accordance with DIN 8152

Characteristics

- very high breaking strength
- high transmission of force
- very wear-resistant

Surface

- factory lubrication or lightly oiled

19



LANGGLIEDERKETTEN

DOUBLE PITCH ROLLER CHAINS

Ausführung

- Rollenketten nach Werknorm
- Simplex
- Förderketten

Eigenschaften

- vorgereckt mit min. $\frac{1}{3}$ der Bruchkraft

Oberfläche

- mit Werksfettung bzw. leicht geölt

Design

- roller chains due to factory standard
- simplex
- conveyor chains

Characteristics

- pre-stretched with at least $\frac{1}{3}$ of breaking strength

Surface

- factory lubrication or lightly oiled

20



ROLLENKETTEN MIT VERGRÖSSERTEM SPIEL

SIDE BOW ROLLER CHAINS

Ausführung

- Teilung 1"
- Simplex

Eigenschaften

- Hauptabmessung ähnlich DIN 8187
- kaltfließgepresste Rollen
- mit Winkellaschen ähnlich WA 1604

Oberfläche

- ungefettet - mit Werksfettung - Fettung nach Anwendung (hitze-/kältebest., Lebensmittelfett)
- galvanisch verzinkt/ blau chromatiert bis 16 B
- galvanisch vernickelt

Design

- pitch 1"
- simplex

Characteristics

- main dimensions similar to DIN 8187
- cold-extruded rollers
- with bent plates similar to WA 1604

Surface

- ungreased - factory lubrication - lubrication due to application conditions (heat-/cold-resistant, foodstuff lubricating grease)
- galvanic zinc-plated/blue chromated up to 16 B
- galvanic nickel-plated

20



LANDMASCHINENKETTEN

AGRICULTURAL CHAINS



Ausführung

- Europäische Bauart
- Amerikanische Bauart
- METEOR-Norm

Eigenschaften

- kaltfließgepresste Rollen
- Kalott-Rollen
- gewinkelte Rollen

Oberfläche

- ungefettet - mit Werksfettung - Fettung nach Anwendung (hitze-/kältebest., Lebensmittelfett)
- galvanisch verzinkt/ blau chromatiert bis 16 B
- galvanisch vernickelt

Design

- European design
- American design
- METEOR factory standard

Characteristics

- cold extruded rollers
- calotte rollers
- lapped rollers

Surface

- ungreased - factory lubrication - lubrication due to application conditions (heat-/cold-resistant, foodstuff lubricating grease)
- galvanic zinc-plated/blue chromated up to 16 B
- galvanic nickel-plated

Ausführung

- Europäische Bauart
- Amerikanische Bauart
- METEOR-Norm

Eigenschaften

- kaltfließgepresste Rollen
- Kalott-Rollen
- gewickelte Rollen
- vorgereckt mit min. $\frac{1}{3}$ der Bruchkraft
- Laschen aus Vergütungsstahl
- Rollen, Buchsen, Bolzen aus Einsatzstahl

Oberfläche

- ungefettet - mit Werksfettung - Fettung nach Anwendung (hitze-/kältebest., Lebensmittelfett)
- galvanisch verzinkt/ blau chromatiert bis 16 B
- galvanisch vernickelt

Design

- European design
- American design
- METEOR factory standard

Characteristics

- cold extruded rollers
- calotte rollers
- lapped rollers
- pre-stretched with at least $\frac{1}{3}$ of breaking strength plates out from tempered steel
- rollers, bushes, pins out from hardened steel

Surface

- ungreased - factory lubrication - lubrication due to application conditions (heat-/cold-resistant, foodstuff lubricating grease)
- galvanic zink-plated/blue chromated up to 16 B
- galvanic nickel-plated



21

ROLLENKETTEN MIT KUNSTSTOFFTEILEN

ROLLER CHAINS WITH PLASTIC PARTS



Ausführung

- Teilung $\frac{3}{4}$ " und 1"

Eigenschaften

- Staurolle aus Stahl

Oberfläche

- ungefettet - mit Werksfettung - Fettung nach Anwendung (hitze-/kältebest., Lebensmittelfett)

Design

- pitches $\frac{3}{4}$ " and 1"

Characteristics

- transport rollers out from steel

Surface

- ungreased - factory lubrication - lubrication due to application conditions (heat-/cold-resistant, foodstuff lubricating grease)



22

STAUFÖRDERKETTEN

ACCUMULATION CHAINS

Ausführung

- Edelstahlketten
- verzinkte und vernickelte Rollenketten
- Europäische Bauart
- Amerikanische Bauart
- METEOR-Norm

Eigenschaften

Oberfläche

- ungefettet - mit Werksfettung - Fettung nach Anwendung (hitze-/kältebest., Lebensmittelfett)

Design

- stainless steel chains
- nickel and zink plated chains
- European design
- American design
- METEOR factory standard

Characteristics

Surface

- ungreased - factory lubrication - lubrication due to application conditions (heat-/cold-resistant, foodstuff lubricating grease)



23

ROSTFREIE ROLLENKETTEN

STAINLESS STEEL CHAINS



- Pflege und Wartung von Rollenkettengetrieben
- Hinweise für Kettenbestellung
- Umrechnungstabelle für metrische Maßeinheiten

- Note to order chain
- Service and maintenance of roller chain drive
- Metric conversion table



24

SONSTIGES

MISCELLANEOUS

ROLLENKETTEN NACH DIN 8187

ROLLER CHAINS

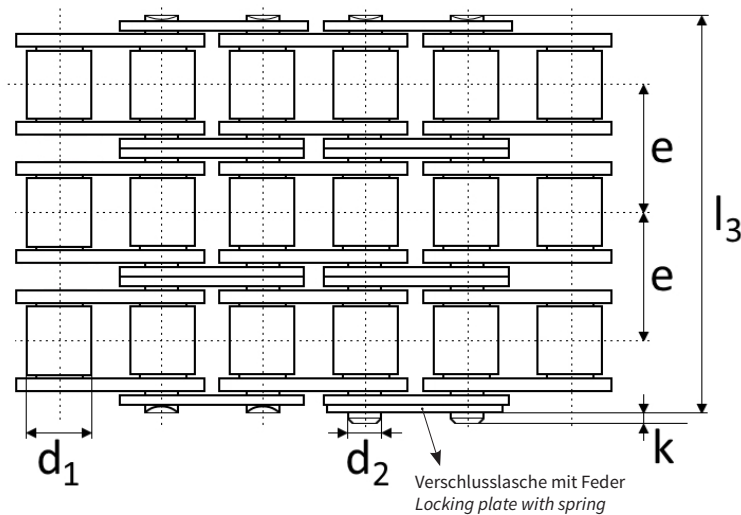
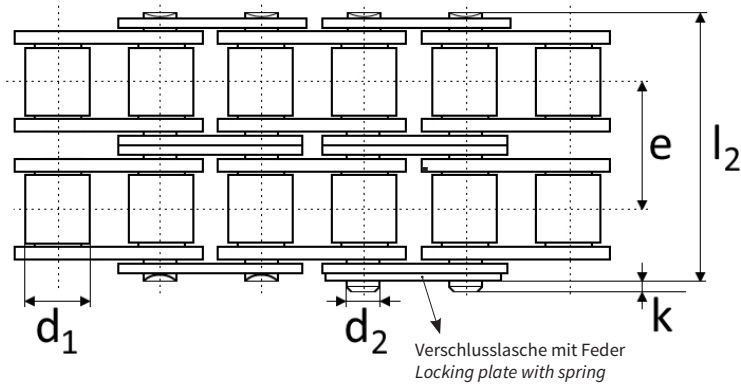
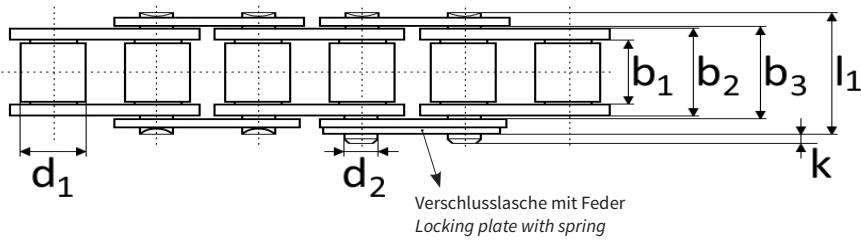

Teilung	p	Pitch
Innere Breite	b_{1 min}	Inside width
Rollen Ø	d_{1 max}	Roller Ø
Bolzen Ø	d_{2 max}	Pin Ø
Bruchkraft	F_B	Breaking load
Meßkraft	N	Measured strength
Gelenkfläche	f	Link surface
Gewicht	q	Weight

Innenglied
Inside link

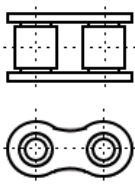

B

Außenglied
Outside link

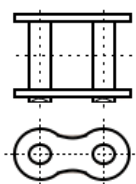

A

Verbindungsglied
mit Feder
Connecting link
with spring clip

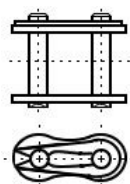

E

Verbindungsglied
mit Splinten
Connecting link
with splint pins

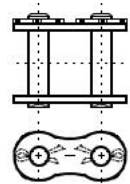

S

Gekröpftes Glied
mit Splint
Cranked link
with splint pin

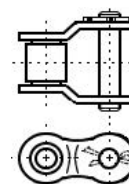

L

Gekröpftes
Doppelglied
Cranked
double link

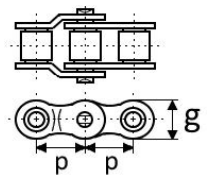

C

Laufrichtung
Running direction

Beim Einsatz von gekröpften Gliedern darf nur mit 80% der Bruchkraft gerechnet werden.
When cranked links are used only 80% of the breaking load may be calculated.

	ISO Nr. ISO No.	p x b ₁	p mm	b _{1 min} mm	b _{2 max} mm	b _{3 min} mm	d _{1 max} mm	d _{2 max} mm	d _{3 min} mm	e mm	g _{max} mm	h _{min} mm	k _{max} mm	l ₁ , l ₂ , l _{3 max} mm	F _B N _{min}	N	f cm ²	q kg/m
SIMPLEX	04	6,0 x 2,8mm	6,0	2,8	4,1	4,2	4,0	1,85	1,88	-	5,0	5,2	2,9	7,4	3 000	30	0,08	0,12
	05B-1	8,0 x 3,0mm	8,0	3,0	4,77	4,9	5,0	2,31	2,36	-	7,1	7,4	3,1	8,6	5 000	50	0,11	0,18
	*06B-1	$\frac{3}{8} \times \frac{7}{32}$ "	9,525	5,72	8,53	8,66	6,35	3,28	3,33	-	8,2	8,6	3,3	13,5	9 000	90	0,28	0,41
	081	$\frac{1}{2} \times \frac{1}{8}$ "	12,7	3,3	5,8	5,93	7,75	3,66	3,71	-	9,9	10,2	1,5	10,2	8 200	82	0,21	0,28
	082	$\frac{1}{2} \times \frac{3}{32}$ "	12,7	2,38	4,6	4,73	7,75	3,66	3,71	-	9,9	10,2	-	8,2	10 000	100	0,17	0,26
	083	$\frac{1}{2} \times \frac{3}{16}$ "	12,7	4,88	7,9	8,03	7,75	4,09	4,14	-	10,3	10,6	1,5	12,9	12 000	120	0,32	0,42
	084	$\frac{1}{2} \times \frac{3}{16}$ "	12,7	4,88	8,8	8,93	7,75	4,09	4,14	-	11,1	11,5	1,5	14,8	16 000	160	0,36	0,59
	085	$\frac{1}{2} \times \frac{1}{4}$ "	12,7	6,38	9,07	9,2	7,77	3,58	3,63	-	9,9	10,2	2,0	14,0	6 800	68	0,32	0,38
	*08B-1	$\frac{1}{2} \times \frac{5}{16}$ "	12,7	7,75	11,3	11,43	8,51	4,45	4,5	-	11,8	12,1	3,9	17,0	18 000	180	0,5	0,7
	*10B-1	$\frac{5}{8} \times \frac{3}{8}$ "	15,875	9,65	13,28	13,41	10,16	5,08	5,13	-	14,7	15,0	4,1	19,6	22 400	224	0,67	0,95
	*12B-1	$\frac{3}{4} \times \frac{7}{16}$ "	19,05	11,68	15,62	15,75	12,07	5,72	5,77	-	16,1	16,4	4,6	22,7	29 000	290	0,89	1,25
	*16B-1	1" x 17,02mm	25,4	17,02	25,4	25,6	15,88	8,28	8,34	-	21,0	21,4	5,4	36,1	60 000	600	2,1	2,7
	*20B-1	$1 \frac{1}{4} \times \frac{3}{4}$ "	31,75	19,56	29,0	29,2	19,05	10,19	10,26	-	26,4	26,7	6,1	43,2	95 000	950	2,96	3,6
	24B-1	$1 \frac{1}{2} \times 1$ "	38,1	25,4	37,9	38,2	25,4	14,63	14,71	-	33,4	33,8	6,6	53,4	160 000	1 600	5,54	6,7
	28B-1	$1 \frac{3}{4} \times 1 \frac{1}{4}$ "	44,45	30,99	46,5	46,8	27,94	15,9	15,98	-	37,0	37,5	7,4	65,1	200 000	2 000	7,39	8,3
	32B-1	$2 \times 1 \frac{1}{4}$ "	50,8	30,99	45,5	45,8	29,21	17,81	17,9	-	42,2	42,8	7,9	67,4	250 000	2 500	8,1	10,5
	40B-1	$2 \frac{1}{2} \times 1 \frac{1}{2}$ "	63,5	38,1	55,7	56,0	39,37	22,89	23,0	-	52,9	53,5	10,0	82,6	355 000	3 550	12,75	16,0
	48B-1	$3 \times 1 \frac{3}{4}$ "	76,2	45,72	70,5	71,0	48,26	29,24	29,35	-	63,8	64,6	10,0	99,1	560 000	5 600	20,61	25,0
DUPEX	05B-2	8,0 x 3,0mm	8,0	3,0	4,77	4,9	5,0	2,31	2,36	5,64	7,1	7,4	3,1	14,3	7 800	78	0,22	0,36
	*06B-2	$\frac{3}{8} \times \frac{7}{32}$ "	9,525	5,72	5,53	8,66	6,35	3,28	3,33	10,24	8,2	8,6	3,3	23,8	16 900	169	0,56	0,78
	*08B-2	$\frac{1}{2} \times \frac{5}{16}$ "	12,7	7,75	11,3	11,43	8,51	4,45	4,5	13,92	11,8	12,1	3,9	31,0	32 000	320	1,01	1,35
	*10B-2	$\frac{5}{8} \times \frac{3}{8}$ "	15,875	9,65	13,28	13,41	10,16	5,08	5,13	16,59	14,7	15,0	4,1	36,2	44 500	445	1,34	1,8
	*12B-2	$\frac{3}{4} \times \frac{7}{16}$ "	19,05	11,68	15,62	15,75	12,07	5,72	5,77	19,46	16,1	16,4	4,6	42,2	57 800	578	1,79	2,5
	*16B-2	1" x 17,02mm	25,4	17,02	25,4	25,6	15,88	8,28	8,34	31,88	21,0	21,4	5,4	68,0	106 000	1 060	4,21	5,4
	*20B-2	$1 \frac{1}{4} \times \frac{3}{4}$ "	31,75	19,56	29	29,2	19,05	10,19	10,26	36,45	26,4	26,7	6,1	79,0	170 000	1 700	5,91	7,2
	24B-2	$1 \frac{1}{2} \times 1$ "	38,1	25,4	37,9	38,2	25,4	14,63	14,71	48,36	33,4	33,8	6,6	101,0	280 000	2 800	11,09	13,5
	28B-2	$1 \frac{3}{4} \times 1 \frac{1}{4}$ "	44,45	30,99	46,5	46,8	27,94	15,9	15,98	59,56	37,0	37,7	7,4	124,0	360 000	3 600	14,79	16,6
	32B-2	$2 \times 1 \frac{1}{4}$ "	50,8	30,99	45,5	45,8	29,21	17,81	17,9	58,55	42,2	42,8	7,9	126,0	450 000	4 500	16,21	21,0
TRIPLEX	*06B-3	$\frac{3}{8} \times \frac{7}{32}$ "	9,525	5,72	8,53	8,66	6,35	3,28	3,33	10,24	8,2	8,6	3,3	34,0	24 900	249	0,84	1,18
	*08B-3	$\frac{1}{2} \times \frac{5}{16}$ "	12,7	7,75	11,3	11,43	8,51	4,45	4,5	13,92	11,8	12,1	3,9	44,9	47 500	475	1,51	2,0
	*10B-3	$\frac{5}{8} \times \frac{3}{8}$ "	15,875	9,65	13,28	13,41	10,16	5,08	5,13	16,59	14,7	15,0	4,1	52,8	66 700	667	2,02	2,8
	*12B-3	$\frac{3}{4} \times \frac{7}{16}$ "	19,05	11,68	15,62	15,75	12,07	5,72	5,77	19,46	16,1	16,4	4,6	61,7	86 700	867	2,68	3,8
	*16B-3	1" x 17,02mm	25,4	17,02	25,4	25,6	15,88	8,28	8,34	31,88	21,0	21,4	5,4	99,9	160 000	1 600	6,31	8,0
	*20B-3	$1 \frac{1}{4} \times \frac{3}{4}$ "	31,75	19,56	29,0	29,2	19,05	10,19	10,26	36,45	26,4	26,7	6,1	116,0	250 000	2 500	8,87	11,0
	24B-3	$1 \frac{1}{2} \times 1$ "	38,1	25,4	37,9	38,2	25,4	14,63	14,71	48,36	33,4	33,8	6,6	150,0	425 000	4 250	16,63	21,0
	28B-3	$1 \frac{3}{4} \times 1 \frac{1}{4}$ "	44,45	30,99	46,5	46,8	27,94	15,9	15,98	59,56	37,0	37,5	7,4	184,0	530 000	5 300	22,18	25,0
	32B-3	$2 \times 1 \frac{1}{4}$ "	50,8	30,99	45,5	45,8	29,21	17,81	17,9	58,55	42,2	42,8	7,9	184,0	670 000	6 700	24,31	32,0
	40B-3	$2 \frac{1}{2} \times 1 \frac{1}{2}$ "	63,5	38,1	55,7	56,0	39,37	22,89	23,0	72,29	52,9	53,5	10,0	227,0	950 000	9 500	38,25	48,0
48B-3	$3 \times 1 \frac{3}{4}$ "	76,2	45,72	70,5	71,0	48,26	29,24	29,35	91,21	63,8	64,6	10,0	281,0	1 500 000	15 000	61,84	75,0	

* auch mit geraden Laschen lieferbar
can also be supplied with straight plates

Andere Ketten auf Anfrage
Other chains upon request

ROLLENKETTEN NACH DIN 8188

ROLLER CHAINS

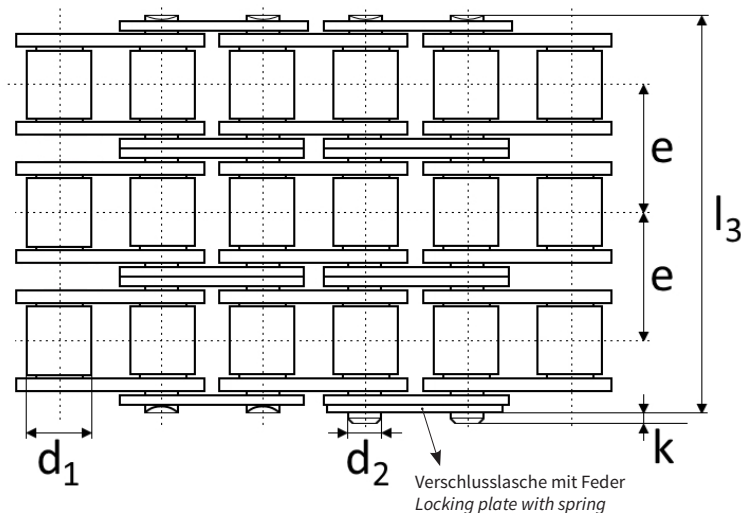
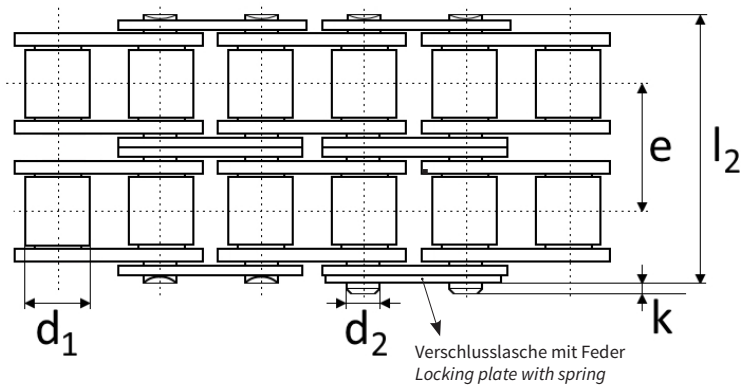
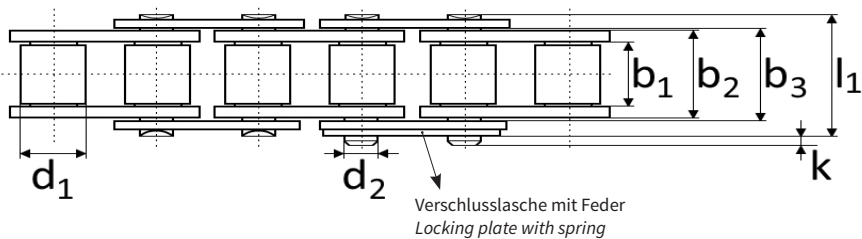

Teilung	p	Pitch
Innere Breite	b_{1 min}	Inside width
Rollen Ø	d_{1 max}	Roller Ø
Bolzen Ø	d_{2 max}	Pin Ø
Bruchkraft	F_B	Breaking load
Meßkraft	N	Measured strength
Gelenkfläche	f	Link surface
Gewicht	q	Weight

Innenglied
Inside link

Außenglied
Outside link

Verbindungsglied
mit Feder
Connecting link
with spring clip

Verbindungsglied
mit Splinten
Connecting link
with splint pins

Gekröpftes Glied
mit Splint
Cranked link
with splint pin

Gekröpftes
Doppelglied
Cranked
double link

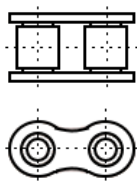

B

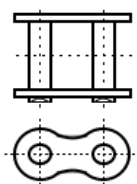

A

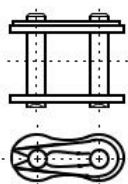

E

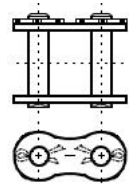

S

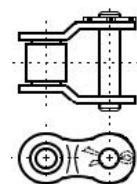

L

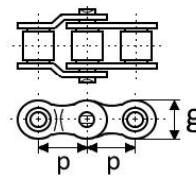

C

Laufrichtung
Running direction

Beim Einsatz von gekröpften Gliedern darf nur mit 80% der Bruchkraft gerechnet werden.
When cranked links are used only 80% of the breaking load may be calculated.

	ISO Nr. ISO No.	$p \times b_1$	p mm	$b_{1 \text{ min}}$ mm	$b_{2 \text{ max}}$ mm	$b_{3 \text{ min}}$ mm	$d_{1 \text{ max}}$ mm	$d_{2 \text{ max}}$ mm	$d_{3 \text{ min}}$ mm	e mm	g_{max} mm	h_{min} mm	k_{max} mm	l_1, l_2, l_3 mm	F_B N_{min}	N	f cm ²	q kg/m
SIMPLEX	08A-1	$\frac{1}{2} \times \frac{5}{16}''$	12,7	7,85	11,15	11,28	7,95	3,96	4,01	-	12,0	12,4	3,9	17,8	14 100	141	0,44	0,6
	10A-1	$\frac{5}{8} \times \frac{3}{8}''$	15,875	9,4	13,8	13,93	10,16	5,08	5,13	-	15,0	15,4	4,1	21,8	22 200	222	0,7	1,0
	12A-1	$\frac{3}{4} \times \frac{1}{2}''$	19,05	12,57	17,7	17,85	11,91	5,94	5,99	-	18,0	18,4	4,6	26,9	31 800	318	1,05	1,5
	16A-1	$1 \times \frac{5}{8}''$	25,4	15,75	22,5	22,7	15,88	7,92	7,98	-	24,1	24,4	5,4	33,5	56 700	567	1,78	2,6
	20A-1	$1 \frac{1}{4} \times \frac{3}{4}''$	31,75	18,9	27,4	27,6	19,05	9,53	9,59	-	30,1	30,5	6,1	41,1	88 500	885	2,61	3,7
	24A-1	$1 \frac{1}{2} \times 1''$	38,1	25,22	35,3	35,6	22,23	11,1	11,17	-	36,2	36,6	6,6	50,8	127 000	1 270	3,92	5,5
	28A-1	$1 \frac{3}{4} \times 1''$	44,45	25,22	37,0	37,3	25,4	12,7	12,77	-	42,2	42,7	7,4	54,9	172 400	1 724	4,7	7,5
	32A-1	$2 \times 1 \frac{1}{4}''$	50,8	31,55	45,0	45,3	28,58	14,27	14,35	-	48,2	48,8	7,9	65,5	226 800	2 268	6,42	9,7
	40A-1	$2 \frac{1}{2} \times 1 \frac{1}{2}''$	63,5	37,85	54,7	55,0	39,68	19,84	19,92	-	60,3	61,0	10,0	80,3	353 800	3 538	10,85	15,8
DUPLEX	08A-2	$\frac{1}{2} \times \frac{5}{16}''$	12,7	7,85	11,15	11,28	7,95	3,96	4,01	14,38	12,0	12,4	3,9	32,3	28 200	282	0,88	1,2
	10A-2	$\frac{5}{8} \times \frac{3}{8}''$	15,875	9,4	13,8	13,93	10,16	5,08	5,13	18,11	15,0	15,4	4,1	39,9	44 400	444	1,4	1,9
	12A-2	$\frac{3}{4} \times \frac{1}{2}''$	19,05	12,57	17,7	17,85	11,91	5,94	5,99	22,78	18,0	18,4	4,6	49,8	63 600	636	2,1	2,9
	16A-2	$1 \times \frac{5}{8}''$	25,4	15,75	22,5	22,7	15,88	7,92	7,98	29,29	24,1	24,4	5,4	62,7	113 400	1 134	3,56	5,0
	20A-2	$1 \frac{1}{4} \times \frac{3}{4}''$	31,75	18,9	27,4	27,6	19,05	9,53	9,59	35,76	30,1	30,5	6,1	77,0	177 000	1 770	5,22	7,3
	24A-2	$1 \frac{1}{2} \times 1''$	38,1	25,22	35,3	35,6	22,23	11,1	11,17	45,44	36,2	36,6	6,6	96,3	254 000	2 540	7,84	10,9
	28A-2	$1 \frac{3}{4} \times 1''$	44,45	25,22	37,0	37,3	25,4	12,7	12,77	48,87	42,2	42,7	7,4	103,0	344 800	3 448	9,4	14,4
	32A-2	$2 \times 1 \frac{1}{4}''$	50,8	31,55	45,0	45,3	28,58	14,27	14,35	58,55	48,2	48,8	7,9	124,0	453 600	4 536	12,84	19,0
	40A-2	$2 \frac{1}{2} \times 1 \frac{1}{2}''$	63,5	37,85	54,7	55,0	39,68	19,84	19,92	71,55	60,3	61,0	10,0	151,0	707 600	7 076	21,7	32,0
TRIPLEX	08A-3	$\frac{1}{2} \times \frac{5}{16}''$	12,7	7,85	11,15	11,28	7,95	3,96	4,01	14,38	12,0	12,4	3,9	46,7	42 300	423	1,32	1,8
	10A-3	$\frac{5}{8} \times \frac{3}{8}''$	15,875	9,4	13,8	13,93	10,16	5,08	5,13	18,11	15,0	15,4	4,1	57,9	66 600	666	2,1	2,9
	12A-3	$\frac{3}{4} \times \frac{1}{2}''$	19,05	12,57	17,7	17,85	11,91	5,94	5,99	22,78	18,0	18,4	4,6	72,6	95 400	954	3,15	4,3
	16A-3	$1 \times \frac{5}{8}''$	25,4	15,75	22,5	22,7	15,88	7,92	7,98	29,29	24,1	24,4	5,4	81,7	170 100	1 701	5,35	7,5
	20A-3	$1 \frac{1}{4} \times \frac{3}{4}''$	31,75	18,9	27,4	27,6	19,05	9,53	9,59	35,76	30,1	30,5	6,1	113,0	265 500	2 655	7,83	11,0
	24A-3	$1 \frac{1}{2} \times 1''$	38,1	25,22	35,3	35,6	22,23	11,1	11,17	45,44	36,2	36,6	6,6	141,0	381 000	3 810	11,76	16,5
	28A-3	$1 \frac{3}{4} \times 1''$	44,45	25,22	37	37,3	25,4	12,7	12,77	48,87	42,2	42,7	7,4	152,0	517 200	5 172	14,1	21,7
	32A-3	$2 \times 1 \frac{1}{4}''$	50,8	31,55	45,0	45,3	28,58	14,27	14,35	58,55	48,2	48,8	7,9	182,0	680 400	6 804	19,26	28,3
	40A-3	$2 \frac{1}{2} \times 1 \frac{1}{2}''$	63,5	37,85	54,7	55,0	39,68	19,84	19,92	71,55	60,3	61,0	10,0	223,0	1 061 400	10 614	32,56	48,0

Andere Ketten auf Anfrage
Other chains upon request

ROLLENKETTEN NACH METEOR-NORM

ROLLER CHAINS DUE TO METEOR STANDARD

ROLLENKETTEN VERSTÄRKT

ROLLER CHAINS REINFORCED

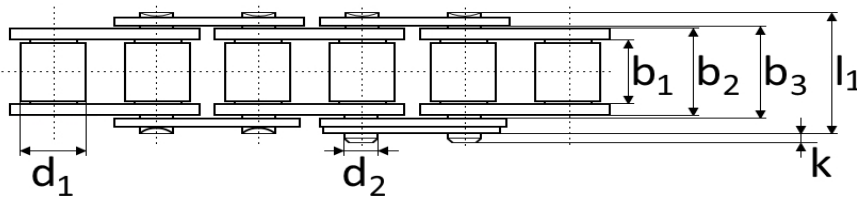

Teilung	p	Pitch
Innere Breite	b_{1 min}	Inside width
Rollen Ø	d_{1 max}	Roller Ø
Bolzen Ø	d_{2 max}	Pin Ø
Bruchkraft	F_B	Breaking load
Meßkraft	N	Measured strength
Gelenkfläche	f	Link surface
Gewicht	q	Weight
Verbindungsglieder	VGL	Links

	ISO Nr. ISO No.	p x b ₁	p mm	b _{1 min} mm	d _{1 min} mm	d _{2 min} mm	b _{2 max} mm	g _{max} mm	e mm	l _{1 max} mm	k _{max} mm	N _{min}	f cm ²	q kg/m	VGL			
															S	C	E	L
SIMPLEX	VK 4	³ / ₄ x ⁷ / ₁₆ "	19,05	11,68	12,07	6,1	17,23	18,0	-	25,9	2,2	40	1,05	1,6	x	-	x	x

Innenglied
Inside link

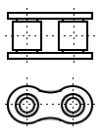

B

Außenglied
Outside link

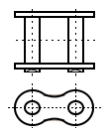

A

Verbindungsglied mit Feder
Connecting link with spring clip

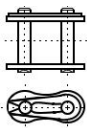

E

Laufrichtung
Running direction

Verbindungsglied mit Splinten
Connecting link with splint pins

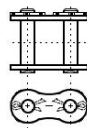

S

Gekröpftes Glied mit Splint
Cranked link with splint pin

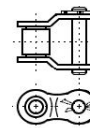

L

Gekröpftes Doppelglied
Cranked double link

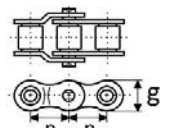

C

ROLLENKETTEN MIT GERADEN LASCHEN

ROLLER CHAINS WITH STRAIGHT SIDE PLATES

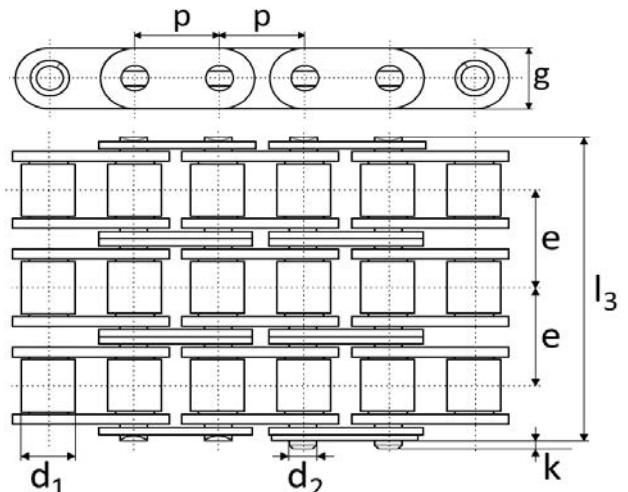
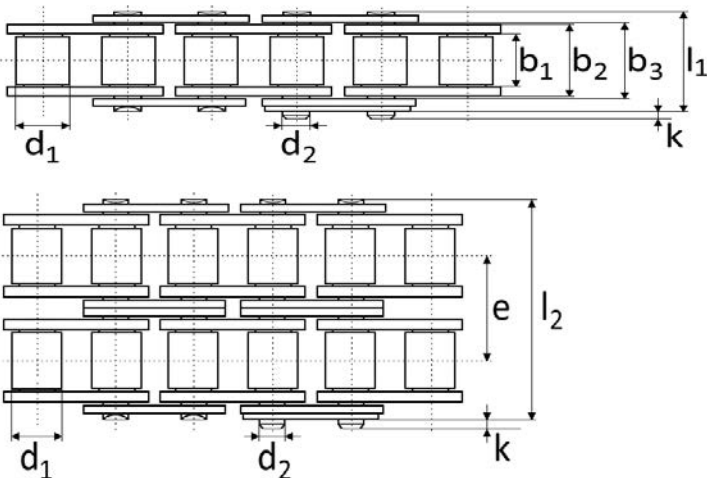

	ISO Nr. ISO No.	p x b ₁	p mm	b _{1 min} mm	d _{1 min} mm	d _{2 min} mm	b _{2 max} mm	g _{max} mm	e mm	l _{1 max} mm	k _{max} mm	N _{min}	f cm ²	q kg/m	VGL			
															S	C	E	L
SIMPLEX	*16GK24-1	1" x 17,02 mm	25,4	17,02	15,88	8,28	25,4	24,0	-	36,1	5,4	60,0	2,1	3,14	x		x	
DUPLEX	*16GK24-2	1" x 17,02 mm	25,4	17,02	15,88	8,28	25,4	24,0	31,88	68,0	5,4	106,0	4,21	8,5	x		x	
TRIPLEX	*16GK24-3	1" x 17,02 mm	25,4	17,02	15,88	8,28	25,4	24,0	31,88	99,9	5,4	160,0	6,31	11,0	x		x	

* Laschenhöhe von DIN 8187 abweichend
Plate height deviating from DIN 8187

Innenglied
Inside link

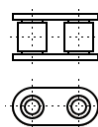

B

Außenglied
Outside link

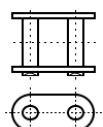

A

Verbindungsglied mit Feder
Connecting link with spring clip

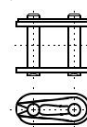

E

Laufrichtung
Running direction

Verbindungsglied mit Splinten
Connecting link with splint pins

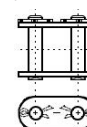

S

Gekröpftes Glied mit Splint
Cranked link with splint pin

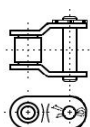

L

Gekröpftes Doppelglied
Cranked double link

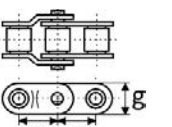

C

ROLLENKETTEN MIT PLANLASCHEN

ROLLER CHAINS WITH STRAIGHT ATTACHMENTS

Planlaschen werden als Außenlaschen geliefert. Zahlreiche Kombinationen mit unterschiedlichen Befestigungselementen, einschließlich mehrreihiger Rollenketten, werden auf Anfrage gefertigt. Straight attachments are supplied as outside plates. Numerous combinations with various mounting elements, incl. multi-strand roller chains, are produced upon request.

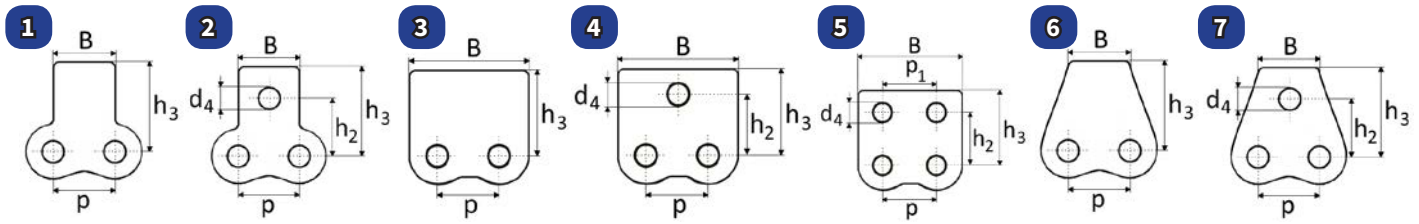

	Ketten-Nr. Chain No.	METEOR Nr. METEOR-No.	$p \times b_1$	Typ Type	p mm	h_2 mm	h_3 mm	d_4 mm	g/2 mm	p_1 mm	B mm	s_{dick} mm	b_{3min} mm
SCHMALE PLANLASCHEN NARROW STRAIGHT PLATES	06B-1	PA 0604	$\frac{3}{8} \times \frac{7}{32}$ "	2	9,525	10,0	14,5	3,0	4,1	-	8,0	1,3	8,66
	08B-1	PA 0804	$\frac{1}{2} \times \frac{5}{16}$ "	2	12,7	14,2	19,8	4,2	5,5	-	13,0	1,6	11,43
	10B-1	PA 1004	$\frac{5}{8} \times \frac{3}{8}$ "	2	15,875	17,0	26,8	5,3	6,5	-	15,0	1,6	13,41
	10B-1	PA 1004.1	$\frac{5}{8} \times \frac{3}{8}$ "	2	15,875	16,3	24,3	5,2	6,8	-	24,0	1,6	13,41
	12B-1	PA 1202	$\frac{3}{4} \times \frac{7}{16}$ "	1	19,05	-	26,0	-	6,6	-	18,0	1,8	15,75
	12B-1	PA 1204	$\frac{3}{4} \times \frac{7}{16}$ "	2	19,05	18,2	26,0	6,0	6,6	-	18,0	1,8	15,75
	12B-1	PA 1204.1	$\frac{3}{4} \times \frac{7}{16}$ "	2	19,05	19,1	29,1	6,2	7,4	-	28,0	1,8	15,75
	16B-1	PA 1602	1" x 17,02 mm	1	25,4	-	40,0	-	9,7	-	24,0	3,1	25,6
	16B-1	PA 1604	1" x 17,02 mm	2	25,4	27,2	40,0	9,0	9,7	-	24,0	3,1	25,6
	16B-1	PA 1604.1	1" x 17,02 mm	2	25,4	24,6	36,6	8,2	10,4	-	36,0	3,0	25,6
	16B-1	PA 1604.2	1" x 17,02 mm	2	25,4	31,1	40,0	9,0	9,7	-	24,0	3,1	25,6
	20B-1	PA 2004	$1 \frac{1}{4} \times \frac{3}{4}$ "	2	31,75	33,0	47,0	10,5	13,0	-	45,0	3,5	29,2
	24B-1	PA 2404	$1 \frac{1}{2} \times 1$ "	2	38,1	36,5	52,5	12,5	15,0	-	54,0	5,0	38,2
	BREITE PLANLASCHEN WIDE STRAIGHT PLATES	06B-1	PA 0608	$\frac{3}{8} \times \frac{7}{32}$ "	4	9,525	10,2	14,5	3,2	4,1	-	17,7	1,3
06B-1		PA 0610	$\frac{3}{8} \times \frac{7}{32}$ "	5	9,525	10,2	14,5	3,2	4,1	9,5	17,7	1,3	8,66
08B-1		PA 0808	$\frac{1}{2} \times \frac{5}{16}$ "	4	12,7	17,0	23,0	4,2	5,5	-	24,3	1,6	11,43
08B-1		PA 0810	$\frac{1}{2} \times \frac{5}{16}$ "	5	12,7	17,0	23,0	4,2	5,5	12,7	24,3	1,6	11,43
10B-1		PA 1008	$\frac{5}{8} \times \frac{3}{8}$ "	4	15,875	16,3	25,8	5,3	6,5	-	29,0	1,6	13,41
10B-1		PA 1010	$\frac{5}{8} \times \frac{3}{8}$ "	5	15,875	16,3	25,8	5,3	6,5	15,8	29,0	1,6	13,41
12B-1		PA 1206	$\frac{3}{4} \times \frac{7}{16}$ "	3	19,05	-	29,0	-	6,6	-	33,2	1,8	15,75
12B-1		PA 1208	$\frac{3}{4} \times \frac{7}{16}$ "	4	19,05	18,3	29,0	6,0	6,6	-	33,2	1,8	15,75
12B-1		PA 1208.1	$\frac{3}{4} \times \frac{7}{16}$ "	4	19,05	18,3	29,0	6,2	9,0	-	37,0	1,8	15,75
12B-1		PA 1210	$\frac{3}{4} \times \frac{7}{16}$ "	5	19,05	18,3	29,0	6,0	6,6	19,0	33,2	1,8	15,75
12B-1		PA 1210.1	$\frac{3}{4} \times \frac{7}{16}$ "	5	19,05	18,3	29,0	6,2	9,0	19,0	37,0	1,8	15,75
16B-1		PA 1606	1" x 17,02 mm	3	25,4	-	40,0	-	9,7	-	45,7	3,1	25,6
16B-1		PA 1608	1" x 17,02 mm	4	25,4	27,2	40,0	8,4	9,7	-	45,7	3,1	25,6
16B-1		PA 1610	1" x 17,02 mm	5	25,4	27,2	40,0	8,4	9,7	25,4	45,7	3,1	25,6
20B-1		PA 2008	$1 \frac{1}{4} \times \frac{3}{4}$ "	4	31,75	33,0	47,5	10,5	13,2	-	57,0	3,5	29,2
20B-1		PA 2010	$1 \frac{1}{4} \times \frac{3}{4}$ "	5	31,75	33,0	47,5	10,5	13,2	31,7	57,0	3,5	29,2
24B-1		PA 2408	$1 \frac{1}{2} \times 1$ "	4	38,1	42,7	61,5	12,5	16,7	-	71,5	5,0	38,2
24B-1		PA 2410	$1 \frac{1}{2} \times 1$ "	5	38,1	42,7	61,5	12,5	16,7	38,1	71,5	5,0	38,2
SONDERPLANLASCHENTGL SPECIAL STRAIGHT SIDE PLATES TGL	12B-1	PA 1212M	$\frac{3}{4} \times \frac{7}{16}$ "	6	19,05	-	24,0	-	7,0	-	10,0	1,8	15,75
	12B-1	PA 1214M	$\frac{3}{4} \times \frac{7}{16}$ "	7	19,05	17,7	24,0	6,0	7,0	-	10,0	1,8	15,75
	16B-1	PA 1616M	1" x 17,02 mm	6	25,4	-	39,8	-	10,0	-	20,0	2,8	25,6
	16B-1	PA 1618M	1" x 17,02 mm	7	25,4	28,8	39,8	8,4	10,0	-	20,0	2,8	25,6

ROLLENKETTEN MIT WINKELLASCHEN

ROLLER CHAINS WITH BENT ATTACHMENTS

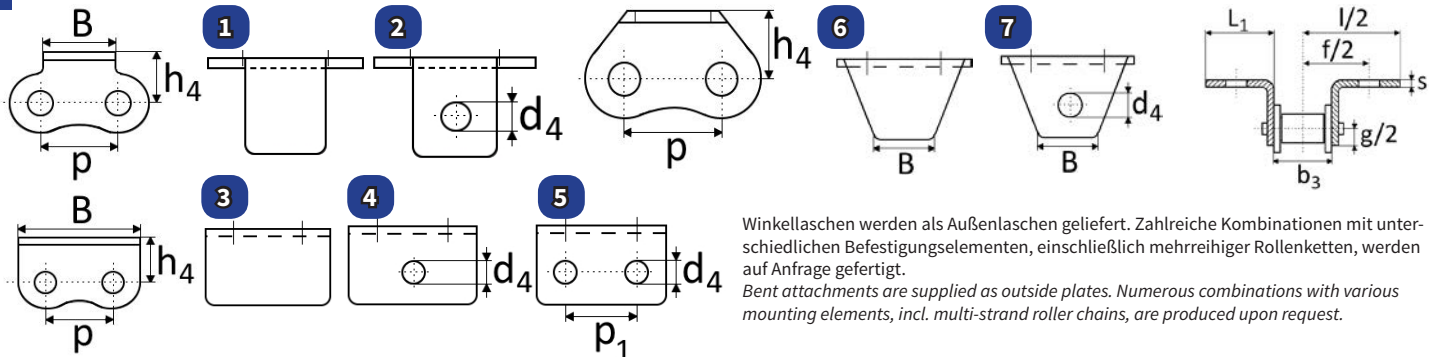

Winkellaschen werden als Außenlaschen geliefert. Zahlreiche Kombinationen mit unterschiedlichen Befestigungselementen, einschließlich mehrreihiger Rollenketten, werden auf Anfrage gefertigt.
Bent attachments are supplied as outside plates. Numerous combinations with various mounting elements, incl. multi-strand roller chains, are produced upon request.

	Ketten-Nr. Chain No.	METEOR Nr. METEOR No.	$p \times b_1$	Typ Type	p mm	h_4 mm	d_4 mm	$f/2$ mm	$l/2$ mm	$g/2$ mm	$l_{1 \max}$ mm	p_1 mm	B mm	s_{dick} mm	$b_{3 \min}$ mm
SCHMALE WINKELASCHEN NARROW BENT ATTACHMENTS	06B-1	WA 0604	$\frac{3}{8} \times \frac{7}{32}$	2	9,525	6,7	3	9,7	14,7	4,1	10,4	-	8,0	1,3	8,66
	08B-1	WA 0804	$\frac{1}{2} \times \frac{5}{16}$	2	12,7	10,0	4,2	12,8	18,7	5,5	12,8	-	13,0	1,6	11,43
	08B-1	WA 0804.1	$\frac{1}{2} \times \frac{5}{16}$	2	12,7	8,0	4,2	13,8	19,8	5,3	14,0	-	18,0	1,5	11,43
	10B-1	WA 1004	$\frac{5}{8} \times \frac{3}{8}$	2	15,875	10,0	5,3	16,6	26,3	6,5	19,6	-	15,0	1,6	13,41
	10B-1	WA 1004.1	$\frac{5}{8} \times \frac{3}{8}$	2	15,875	9,0	5,2	16,8	24,8	6,8	18,0	-	24,0	1,6	13,41
	12B-1	WA 1202	$\frac{3}{4} \times \frac{7}{16}$	1	19,05	12,2	-	-	25,3	6,6	17,4	-	18,0	1,8	15,75
	12B-1	WA 1204	$\frac{3}{4} \times \frac{7}{16}$	2	19,05	12,2	6,0	17,5	25,3	6,6	17,4	-	18,0	1,8	15,75
	12B-1	WA 1204.1	$\frac{3}{4} \times \frac{7}{16}$	2	19,05	10,0	6,2	20,5	30,5	7,4	22,6	-	28,0	1,85	15,75
	16B-1	WA 1602	1 x 17,02 mm	1	25,4	17,0	-	-	41,3	9,7	29,0	-	24,0	3,1	25,6
	16B-1	WA 1604	1 x 17,02 mm	2	25,4	17,0	9,0	28,8	41,3	9,7	29,0	-	24,0	3,1	25,6
	16B-1	WA 1604.1	1 x 17,02 mm	2	25,4	16,0	8,4	27,5	39,5	10,4	26,0	-	36,0	3,0	25,6
	16B-1	WA 1604.2	1 x 17,02 mm	2	25,4	17,0	7,0	28,8	41,9	12,0	29,0	-	24,0	3,0	25,6
	20B-1	WA 2004	$1 \frac{1}{4} \times \frac{3}{4}$	2	31,75	21,5	10,5	32,8	46,8	13,0	32,0	-	45,0	3,5	29,2
	24B-1	WA 2404	$1 \frac{1}{2} \times 1$	2	38,1	25,0	12,5	39,2	55,2	15,0	36,0	-	54,0	5,0	38,2
BREITE WINKELASCHEN WIDE BENT ATTACHMENTS	06B-1	WA 0608	$\frac{3}{8} \times \frac{7}{32}$	4	9,525	6,7	3,2	10,0	14,7	4,1	10,4	-	17,7	1,3	8,66
	06B-1	WA 0610	$\frac{3}{8} \times \frac{7}{32}$	5	9,525	6,7	3,2	10,0	14,7	4,1	10,4	9,5	17,7	1,3	8,66
	08B-1	WA 0808	$\frac{1}{2} \times \frac{5}{16}$	4	12,7	9,5	4,2	16,3	22,3	5,5	16,6	-	24,3	1,6	11,43
	08B-1	WA 0810	$\frac{1}{2} \times \frac{5}{16}$	5	12,7	9,5	4,2	16,3	22,3	5,5	16,6	12,7	24,3	1,6	11,43
	10B-1	WA 1008	$\frac{5}{8} \times \frac{3}{8}$	4	15,875	11,0	5,3	15,3	24,8	6,5	18,1	-	29,0	1,6	13,41
	10B-1	WA 1010	$\frac{5}{8} \times \frac{3}{8}$	5	15,875	11,0	5,3	15,3	24,8	6,5	18,1	15,8	29,0	1,6	13,41
	12B-1	WA 1206	$\frac{3}{4} \times \frac{7}{16}$	3	19,05	12,0	-	-	28,3	6,6	20,5	-	33,2	1,8	15,75
	12B-1	WA 1208	$\frac{3}{4} \times \frac{7}{16}$	4	19,05	12,0	6,0	17,5	28,3	6,6	20,5	-	33,2	1,8	15,75
	12B-1	WA 1210	$\frac{3}{4} \times \frac{7}{16}$	5	19,05	12,0	6,0	17,5	28,3	6,6	20,5	19,0	33,2	1,8	15,75
	16B-1	WA 1610	1 x 17,02 mm	3	25,4	17,0	-	-	41,3	9,7	29,0	-	45,7	3,1	25,6
	16B-1	WA 1612	1 x 17,02 mm	4	25,4	17,0	8,4	28,9	41,3	9,7	29,0	-	45,7	3,1	25,6
	16B-1	WA 1614	1 x 17,02 mm	5	25,4	17,0	8,4	28,9	41,3	9,7	29,0	25,4	45,7	3,1	25,6
	20B-1	WA 2008	$1 \frac{1}{4} \times \frac{3}{4}$	4	31,75	21,0	10,5	34,5	49,4	13,2	34,9	-	57,0	3,5	29,2
	20B-1	WA 2010	$1 \frac{1}{4} \times \frac{3}{4}$	5	31,75	21,0	10,5	34,5	49,4	13,2	34,9	31,7	57,0	3,5	29,2
24B-1	WA 2408	$1 \frac{1}{2} \times 1$	4	38,1	28,0	12,5	44,0	62,4	16,7	43,4	-	71,8	5,0	38,2	
24B-1	WA 2410	$1 \frac{1}{2} \times 1$	5	38,1	28,0	12,5	44,0	62,4	16,7	43,4	38,1	71,8	5,0	38,2	
SONDERWINKELASCHEN TGL SPECIAL BENT ATTACHMENTS TGL	12B-1	WA 1212M	$\frac{3}{4} \times \frac{7}{16}$	6	19,05	11,0	-	-	23,3	7,0	15,4	-	10,0	1,8	15,75
	12B-1	WA 1214M	$\frac{3}{4} \times \frac{7}{16}$	7	19,05	11,0	6,0	17,7	23,3	7,0	15,4	-	10,0	1,8	15,75
	16B-1	WA 1624M	1 x 17,02 mm	6	25,4	18,0	-	-	39,0	10,0	25,7	-	20,0	2,8	25,6
	16B-1	WA 1626M	1 x 17,02 mm	7	25,4	18,0	8,4	29,0	39,0	10,0	25,7	-	20,0	2,8	25,6

ROLLENKETTEN MIT ZACKENLASCHEN

ROLLER CHAINS WITH TOOTHED PLATES

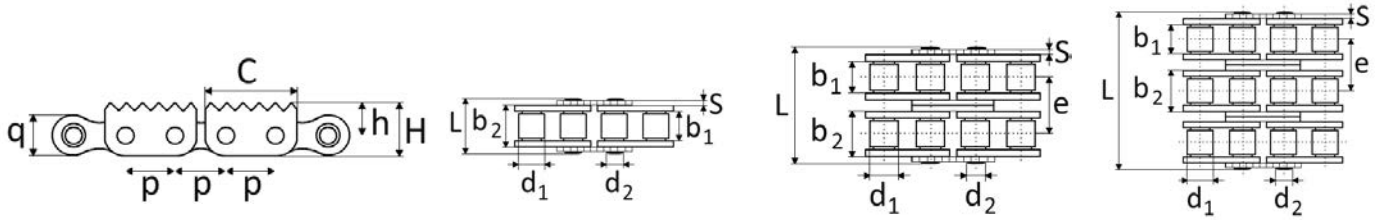

Ketten-Nr. Chain No.	p mm	b _{1min} mm	b _{2max} mm	d ₂ mm	d _{1max} mm	L _{max} mm	q _{max} mm	e mm	h mm	H mm	C mm	S mm	F _B N min.
16B-1 2M3	25,4	17,02	25,45	8,28	15,88	35	20,3	-	14,4	26,5	46	3,1	60 000
16B-2 2M3	25,4	17,02	25,45	8,28	15,88	67,3	20,3	31,88	14,4	26,5	46	3,1	106 000
16B-3 2M3	25,4	17,02	25,45	8,28	15,88	99	20,3	31,88	14,4	26,5	46	3,1	160 000

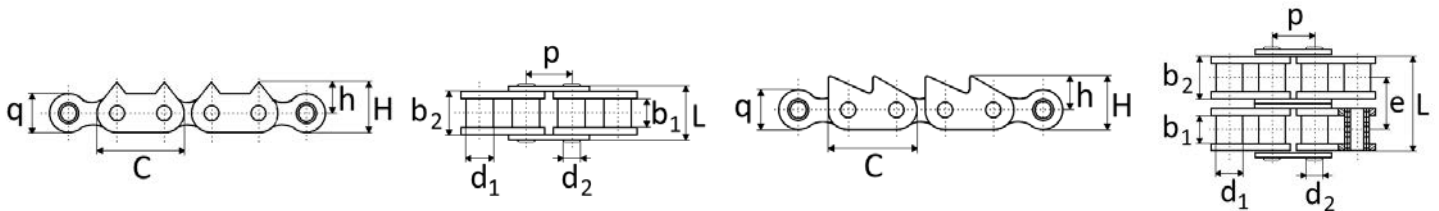

Ketten-Nr. Chain No.	p mm	C mm	b _{1min} mm	b _{2max} mm	d ₂ mm	d _{1max} mm	L _{max} mm	q _{max} mm	e mm	h mm	H mm	F _B N min.
20B-1 2Ma3.101 2T	31,75	57,75	19,56	29,01	10,19	19,05	40,4	26	-	19,9	33	95 000
16B-2 2Ma8.001GL 2T	25,4	47	17,02	25,45	8,28	15,88	66,7	20,3	31,88	18,5	28,65	106 000

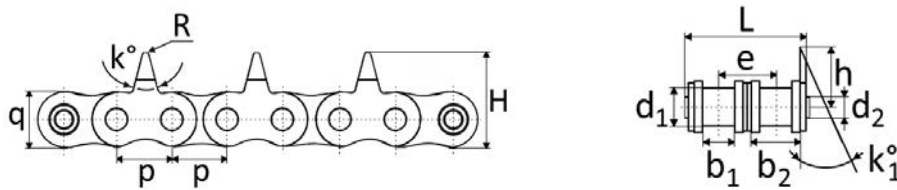

Ketten-Nr. Chain No.	p mm	b _{1min} mm	b _{2max} mm	d ₂ mm	d ₁ mm	L _{max} mm	q mm	e mm	k deg	k ₁ deg	R mm	h mm	H mm	F _B N min.
08B-2 1Ma5.101 2T	12,7	7,75	11,3	4,45	8,51	31	11,8	13,92	30	15	0,5	14,6	20,5	31 800
10B-2 1Ma5.101 2T	15,875	9,65	13,28	5,08	10,16	35,8	14,73	16,59	36	15	--	18,6	25,96	45 400

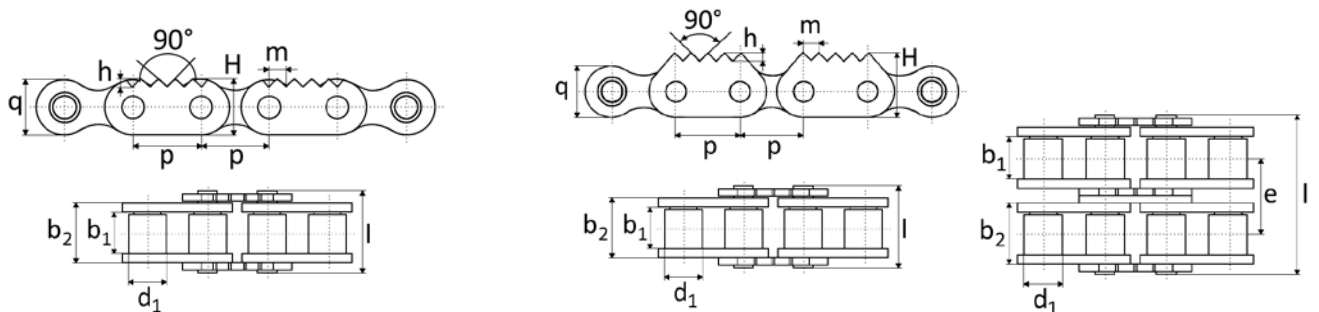

Ketten-Nr. Chain No.	p mm	q mm	d ₁ mm	b ₁ mm	b ₂ mm	h mm	H mm	m mm	e mm	l _{max} mm	F _B N min.
16B-1 2Ma3.104GL 2T.00.00	25,4	20,3	15,88	17,02	25,45	2,5	20,3	6,35	-	35	60 000
16B-1 2Ma3.105GL 2T.00.00	25,4	20,3	15,88	17,02	25,45	3	25,3	6,6	-	35	60 000
16B-2 2Ma3.105GL 1Mz3.105GL 2T.00.00	25,4	20,3	15,88	17,02	25,45	3	25,3	6,6	31,88	67,3	106 000

ROLLENKETTEN MIT VERLÄNGERTEN BOLZEN

ROLLER CHAINS WITH EXTENDED PINS

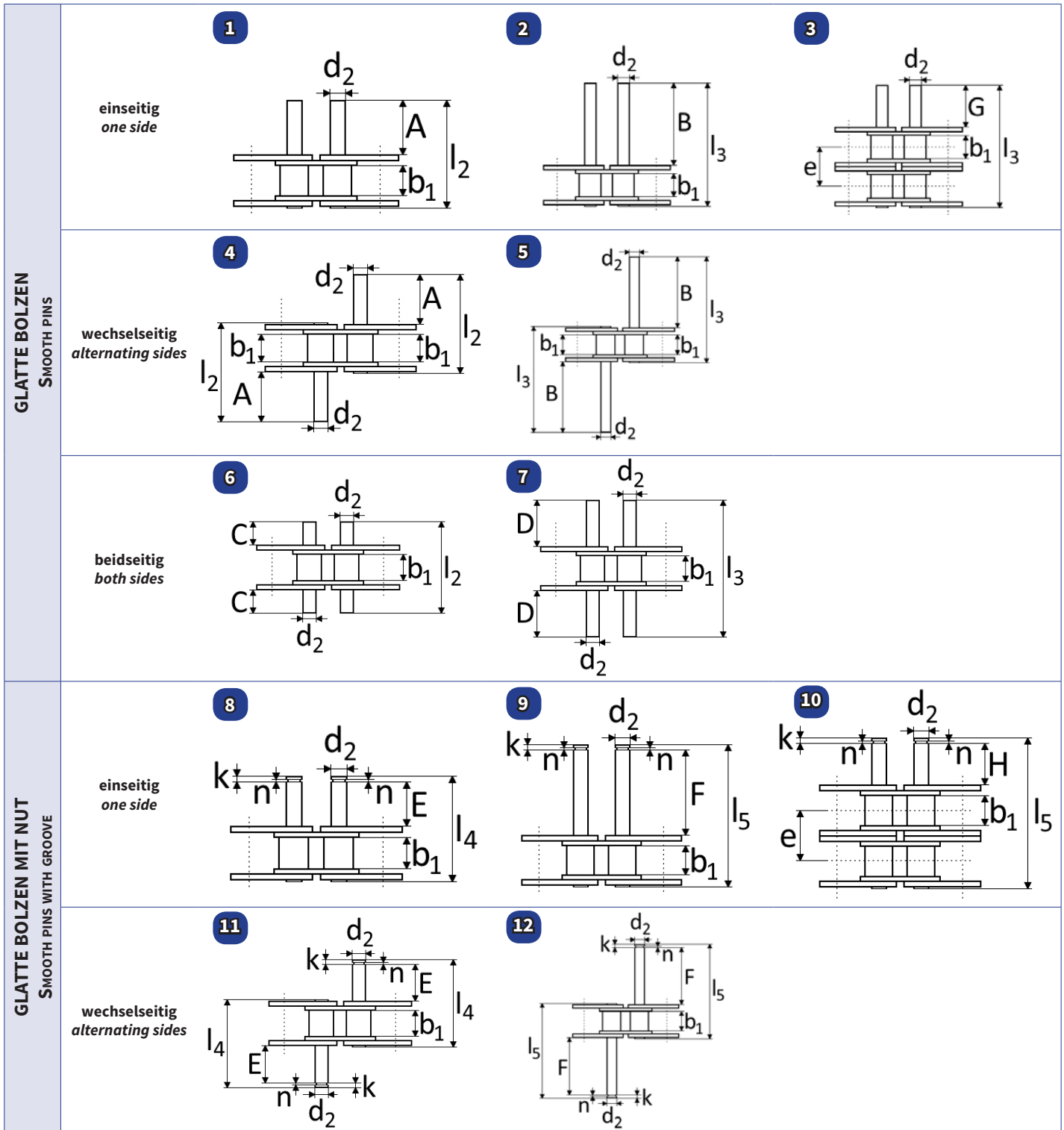

Ketten-Nr. Chain No.	p mm	b _{1min} mm	d _{2max} mm	l ₂ mm	l ₃ mm	l ₄ mm	l ₅ mm	n mm	k mm	A mm	B mm	C mm	D mm	E mm	F mm	G mm	H mm
06B	9,525	5,72	3,28	23,7	33,9	24,4	34,7	0,8	1,8	11,6	21,8	6,3	11,4	11,0	20,5	11,0	10,0
08B	12,7	7,75	4,45	30,9	44,8	32,8	46,8	0,8	2,9	15,0	28,8	8,1	15,0	14,0	28,2	15,0	14,2
10B	15,875	9,65	5,08	35,7	52,3	36,7	54,3	0,8	2,3	17,8	34,5	9,7	17,8	16,8	33,4	17,8	16,8
12B	19,05	11,68	5,72	42,1	61,6	43,1	62,5	1,0	2,4	21,1	40,6	11,4	21,1	19,8	39,1	21,1	19,8
16B	25,4	17,02	8,28	67,1	98,8	69,2	99,4	1,4	3,4	34	65,5	17,7	33,6	32,2	62,0	33,0	30,5
20B	31,75	19,56	10,19	76,8	113,3	79,9	116,4	3,3	4,6	38,2	74,7	20,4	38,6	36,8	73,1	38,8	37,2
24B	38,1	25,4	14,63	100,9	149,9	106,1	154,4	4,2	6,4	49,9	98,9	26,5	50,9	48,8	97,1	50,6	48,8

ROLLENKETTEN MIT U-BÜGELN, MIT/OHNE GUMMIPROFIL

ROLLER CHAINS WITH U-SHAPED BRACKET, WITH/WITHOUT MOLDED RUBBER STRIP

Grundwerte Properties	Farbe Colour	Shore Härte Shore hardness A	Betriebstemperaturen Temperature range °C	Beständigkeit Resistance to					
				Antrieb Wear	Einreisse Scratch	Alterungs Ageing	Benzin Petrol	Öl- und Fett Oil and grease	Heisses Wasser- und Dampf Hot water and steam
Styrol Butadien Kautschuk Styrol Butadien Rubber	elfenbeinweiß, hellgrau ivory-white, light grey	70 + / -	-50 / + 90	+++	++	++	++	++++	++

++++ ausgezeichnet
 excellent
 +++ sehr gut
 very good
 ++ gut
 good
 + gering
 low
 0 unzureichend
 unsuitable

Rollenketten mit U - Bügeln, mit oder ohne Gummiprofil sind in unterschiedlichen Ausführungen erhältlich. Kundenspezifische Anpassungen können nach Absprache vorgenommen werden.

Roller chains with U-shaped brackets, with or without molded rubber strip are available of different variations. Dimensions may be adjusted as agreed by the customer.

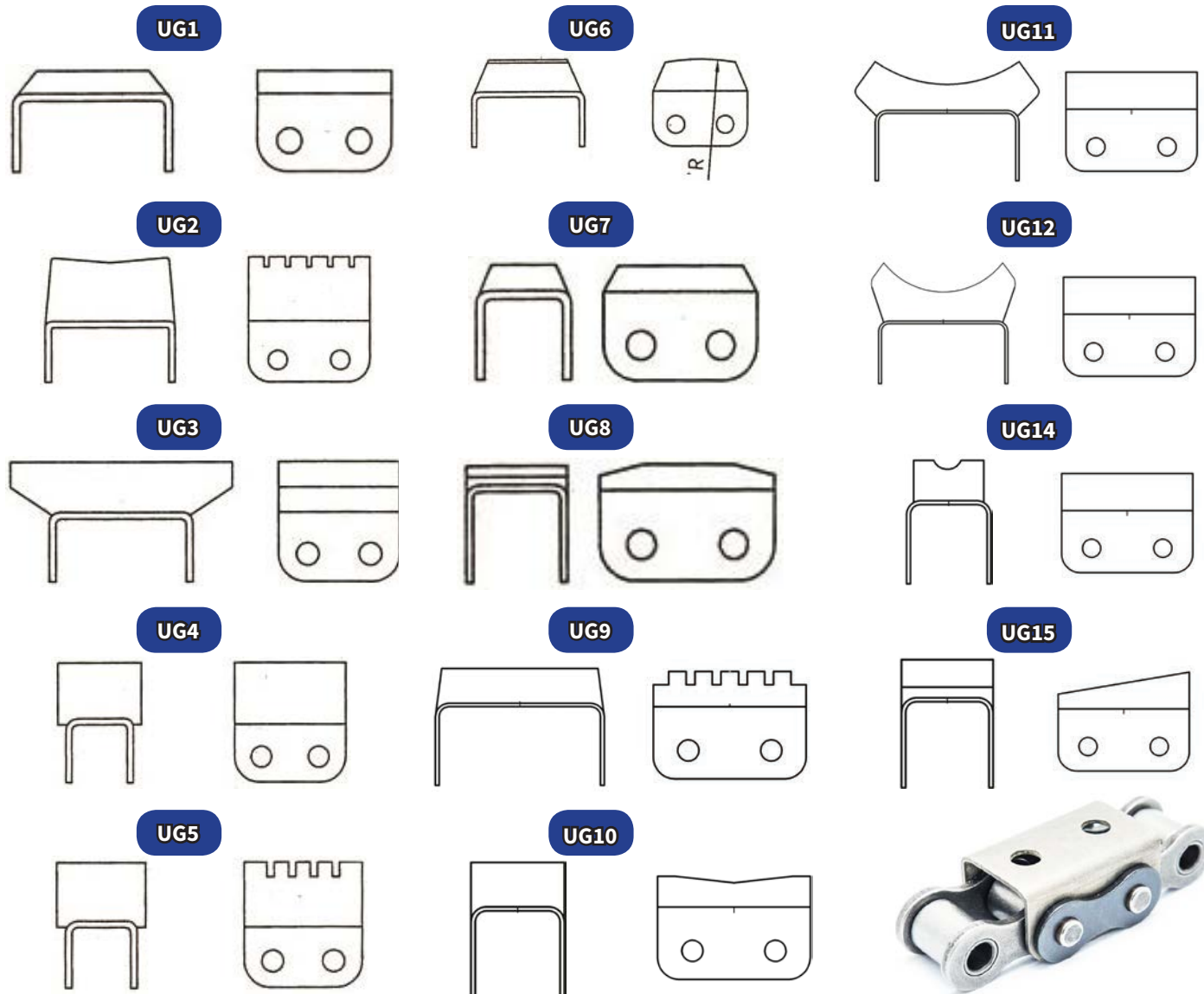
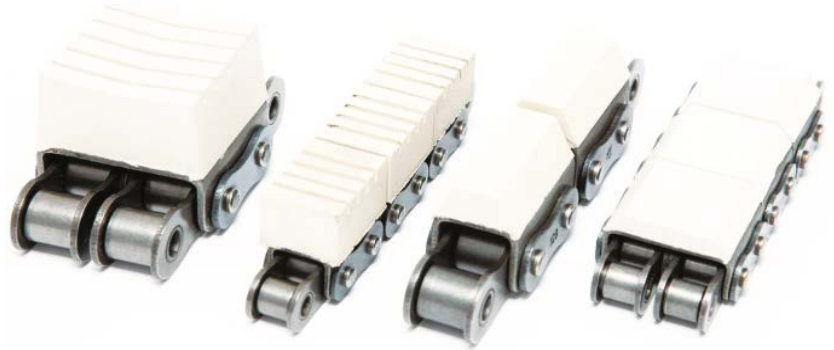

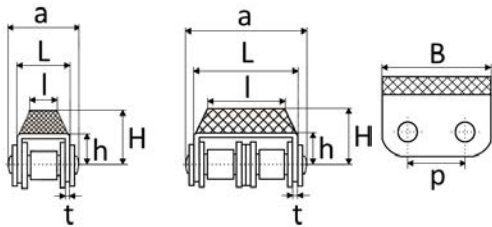

Ketten-Nr. Chain No.	p mm	t mm	l mm	L mm	h mm	H mm	a mm	b mm	F _B N _{min}
08B-1 UG1	12,7	1,3	11,5	14,5	8,3	12,3	19,5	24,32	18 200
08B-2 UG1	12,7	1,3	20	28,4	8,3	12,3	33,5	24,32	32 000
10B-1 UG1	15,875	1,3	11	16,4	10,5	13	21,9	30	23 000
10B-2 UG1	15,875	1,3	29	33	10,5	13	38,9	30	45 400
12B-1 UG1	19,05	1,8	10	19	13	21	25,9	35,6	28 900
12B-2 UG1	19,05	1,8	31	39	12	19,5	45,4	37	57 800
12A-1 UG1	19,05	1,8	19	21,5	13,9	17,9	29,1	35	31 800
16B-1 UG1	25,4	1,8	24,8	30	15,4	21,4	39,3	48	60 000
16B-2 UG1	25,4	1,8	56,8	62	15,4	21,4	70,8	48	106 000
16A-1 UG1	25,4	1,8	21,5	26,7	16,4	22,4	36,1	48	55 600
16A-2 UG1	25,4	1,8	51,3	56,5	16,4	22,4	65,4	48	112 000
20B-1 UG1	31,75	2,4	30	34,8	19	27	46,2	56,15	95 000

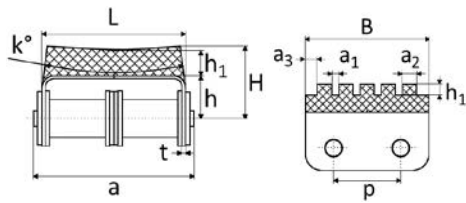

Ketten-Nr. Chain No.	p mm	t mm	k deg	L mm	h mm	h ₁ mm	H mm	a mm	B mm	F _B N _{min}
08B-2 UG21	12,7	1,3	1	28,4	8,3	4,5	16	35,1	24,32	32 000

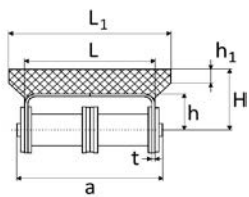

Ketten-Nr. Chain No.	p mm	t mm	L ₁ mm	L mm	h mm	h ₁ mm	H mm	a mm	b mm	F _B N _{min}
08B-2 UG3	12,7	1,3	44	28,4	8,3	5	18,3	33,5	24,32	32 000
10B-2 UG3	15,88	1,3	44	33	10,5	2,5	18,3	38,9	30	45 400

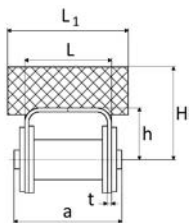

Ketten-Nr. Chain No.	p mm	t mm	L ₁ mm	L mm	h mm	H mm	a mm	B mm	F _B N _{min}
08B-1 UG4	12,7	1,3	18	14,5	8,3	20,3	19,5	24,32	18 200
08B-1 UG42	12,7	1,3	18	14,5	8,3	13,3	19,5	24,32	18 200

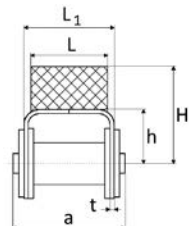

Ketten-Nr. Chain No.	p mm	t mm	L ₁ mm	L mm	h mm	H mm	a mm	B mm	F _B N _{min}
12B-1 UG4	19,05	1,8	18	19,4	13	21	25,9	35,6	28 900
12B-1 UG41	19,05	1,8	18	19,4	13	25	25,9	35,6	28 900

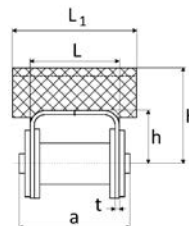

Ketten-Nr. Chain No.	p mm	t mm	L ₁ mm	L mm	h mm	H mm	h ₂ mm	a ₁ mm	a ₂ mm	a mm	B mm	F _B N _{min}
08B-1 UG5	12,7	1,3	18	14,5	8,3	20,3	3	1,5	3	19,5	24,32	18 200
08B-1 UG53	12,7	1,3	18	14,5	8,3	14,3	3	1,5	3	19,5	24,32	18 200

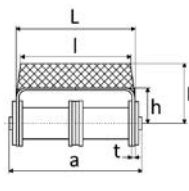

Ketten-Nr. Chain No.	p mm	t mm	l mm	L mm	h mm	H mm	a mm	B mm	b mm	R mm	F _B N _{min}
08B-2 UG6	12,7	1,3	20	28,4	8,3	16,3	33,5	24,32	18	55	32 000

Ketten-Nr. Chain No.	p mm	t mm	k deg	l mm	L mm	h mm	H mm	a mm	B mm	F _B N _{min}
08B-1 UG7	12,7	1,3	30	9,88	14,5	8,3	12,3	19,5	24,32	18 200
08B-2 UG7	12,7	1,3	45	20	28,4	8,3	12,3	33,5	24,32	32 000
08B-2 UG71	12,7	1,3	30	12,7	28,4	8,3	23,3	33,5	24,32	32 000
12B-1 UG7	19,05	1,8	25	14	19,6	13	18	25,9	35,6	28 900
16B-1 UG7	25,4	1,8	30	24,8	30	15,4	21,4	38,7	48	60 000

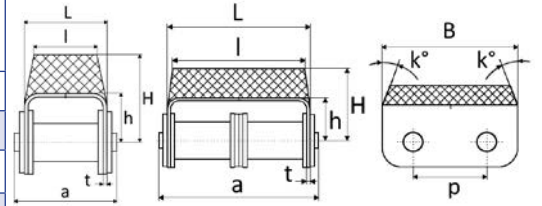

Ketten-Nr. Chain No.	p mm	t mm	L mm	h mm	H mm	c mm	c ₁ mm	a mm	B mm	F _B N _{min}
08B-1 UG8	12,7	1,3	14,5	8,3	12,3	2	5	19,5	24,32	18 200
16B-1 UG8	25,4	1,8	30	15,4	21,4	2,9	11,5	39,3	48	60 000
16B-2 UG8	25,4	1,8	62	15,4	21,4	2,9	11,5	71,4	48	106 000

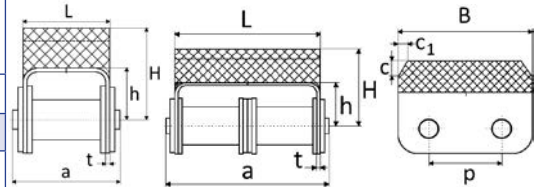

Ketten-Nr. Chain No.	p mm	t mm	k deg	L mm	h mm	h ₁ mm	H mm	a mm	a ₁ mm	a ₂ mm	a ₃ mm	B mm	F _B N _{min}
12B-2 UG9	19,05	1,8	5	39	12	3	28	45,4	1,5	5	3	37	57 800

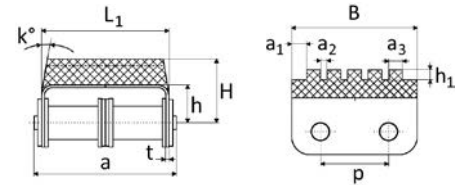

Ketten-Nr. Chain No.	p mm	t mm	L mm	h mm	H mm	h ₁ mm	a ₁ mm	a mm	B mm	F _B N _{min}
16B-1 UG10	25,4	1,8	30	15,4	25,4	3	4	39,3	48	60 000

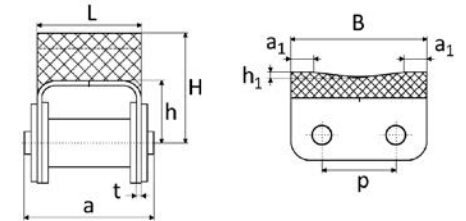

Ketten-Nr. Chain No.	p mm	t mm	L mm	L ₁ mm	L ₂ mm	h mm	h ₁ mm	H mm	R mm	a mm	B mm	F _B N _{min}
08B-2 UG11	12,7	1,3	28,4	39	35	8,3	8	20,8	36	33,5	24,32	31 800

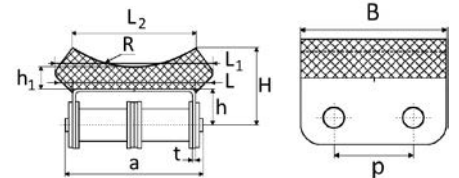

Ketten-Nr. Chain No.	p mm	t mm	k deg	L mm	L ₁ mm	L ₂ mm	h mm	h ₁ mm	H mm	R mm	R ₁ mm	a mm	B mm	F _B N _{min}
08B-2 UG12	12,7	1,3	60	28,4	44	41,5	8,3	8	26,3	27	5	33,5	24,32	31 800

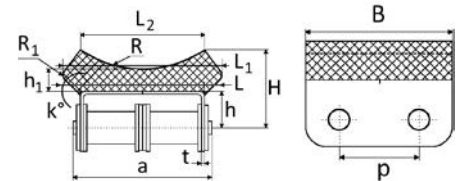

Ketten-Nr. Chain No.	p mm	t mm	R mm	L ₁ mm	L mm	h mm	h ₁ mm	H mm	a mm	B mm	F _B N _{min}
12B-1 UG14	19,05	1,8	3,6	18,4	19,4	13	2,6	23	25,9	35,6	28 900
12B-1 UG141	19,05	1,8	4,76	18,4	19,4	13	3,7	23	25,9	35,6	28 900

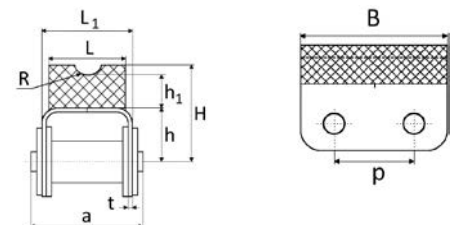

Ketten-Nr. Chain No.	p mm	t mm	k deg	L mm	h mm	H mm	a mm	B mm	F _B N _{min}
16B-1 UG15	25,4	1,8	15	30	15,4	32,9	39,3	48	60 000

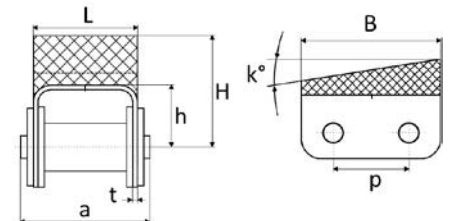

FLYERKETTEN

LEAF CHAINS

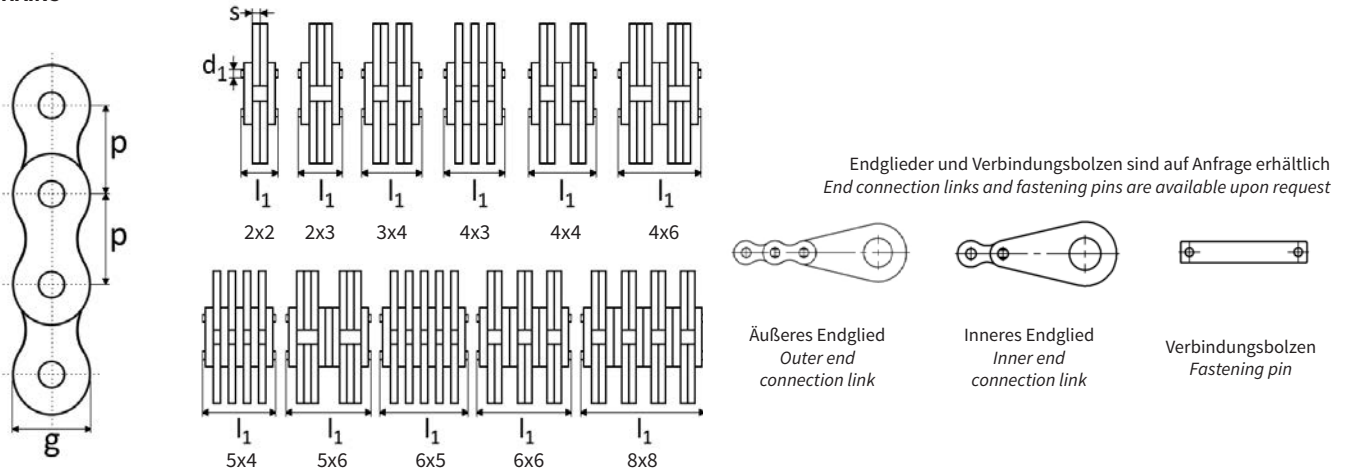

	Ketten-Nr. Chain No.	Laschenkombination Lacing	P		l ₁ mm	d ₁ mm	s mm	g mm	N _{min}
			mm	inch					
LEICHTE REIHE LL LIGHT SERIE LL	LL 0822	2x2	12,7	1/2	8,9	4,45	1,6	10,92	18 200
	LL 0844	4x4	12,7	1/2	15,7	4,45	1,6	10,92	36 400
	LL 0866	6x6	12,7	1/2	22,3	4,45	1,6	10,92	54 600
	LL 0888	8x8	12,7	1/2	29,1	4,45	1,6	10,92	72 800
	LL 1022	2x2	15,875	5/8	9,0	5,08	1,6	13,6	22 700
	LL 1044	4x4	15,875	5/8	15,8	5,08	1,6	13,6	45 400
	LL 1066	6x6	15,875	5/8	22,6	5,08	1,6	13,6	68 100
	LL 1088	8x8	15,875	5/8	29,4	5,08	1,6	13,6	90 800
	LL 1222	2x2	19,05	3/4	10,3	5,72	1,9	16,1	29 500
	LL 1243	4x3	19,05	3/4	16,4	5,72	1,9	16,1	51 650
	LL 1244	4x4	19,05	3/4	18,3	5,72	1,9	16,1	59 000
	LL 1254	5x4	19,05	3/4	20,5	5,72	1,9	16,1	59 000
	LL 1265	6x5	19,05	3/4	24,4	5,72	1,9	16,1	81 100
	LL 1266	6x6	19,05	3/4	26,3	5,72	1,9	16,1	88 500
	LL 1622	2x2	25,4	1	15,9	8,28	3,1	20,3	58 000
	LL 1644	4x4	25,4	1	28,7	8,28	3,1	20,3	116 000
	LL 1666	6x6	25,4	1	41,5	8,28	3,1	20,3	174 000
	LL 1688	8x8	25,4	1	54,0	8,28	3,1	20,3	240 000
SCHWERE REIHE LH HEAVY SERIE LH	LH 1034	3x4	15,875	5/8	20,0	5,94	2,4	14,8	50 100
	LH 1044	4x4	15,875	5/8	22,5	5,94	2,4	14,8	66 800
	LH 1046	4x6	15,875	5/8	27,5	5,94	2,4	14,8	66 800
	LH 1066	6x6	15,875	5/8	32,0	5,94	2,4	14,8	100 200
	LH 1223	2x3	19,05	3/4	19,2	7,94	3,1	18,0	48 900
	LH 1234	3x4	19,05	3/4	25,4	7,94	3,1	18,0	73 400
	LH 1244	4x4	19,05	3/4	28,6	7,94	3,1	18,0	97 800
	LH 1246	4x6	19,05	3/4	36,0	7,94	3,1	18,0	97 800
	LH 1256	5x6	19,05	3/4	38,5	7,94	3,1	18,0	97 800
	LH 1266	6x6	19,05	3/4	41,5	7,94	3,1	18,0	146 800
	LH 1623	2x3	25,4	1	24,0	9,54	3,8	24,1	84 500
	LH 1634	3x4	25,4	1	31,5	9,54	3,8	24,1	126 700
	LH 1644	4x4	25,4	1	35,8	9,54	3,8	24,1	169 000
	LH 1646	4x6	25,4	1	44,0	9,54	3,8	24,1	169 000
	LH 1666	6x6	25,4	1	52,2	9,54	3,8	24,1	253 500
	LH 1688	8x8	25,4	1	69,2	9,54	3,8	24,1	338 000

LANGGLIEDRIGE ROLLENKETTEN

DOUBLE PITCH ROLLER CHAINS

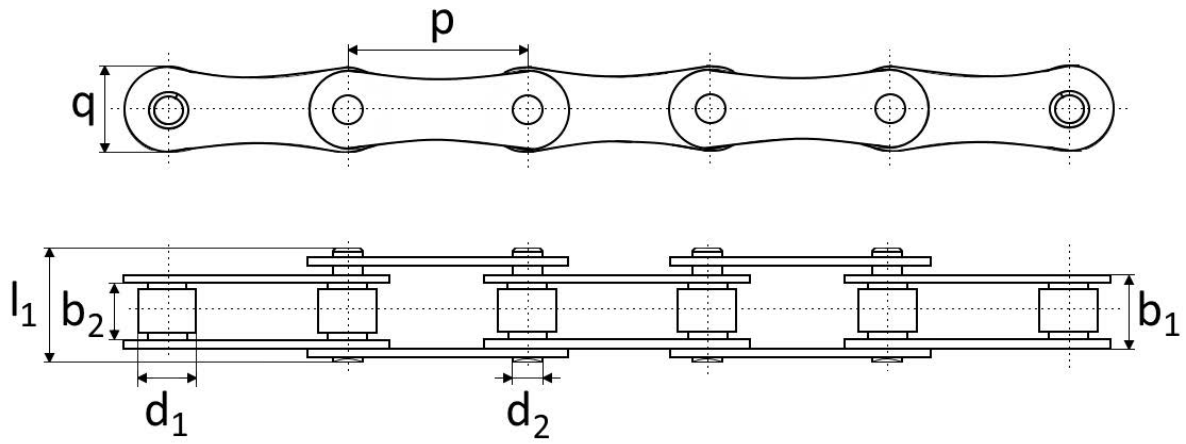

Ketten-Nr. Chain No.	ISO-Nr. ISO No.	p mm	$b_{1\min}$ mm	$b_{2\max}$ mm	d_2 mm	$d_{1\max}$ mm	$l_{1\max}$ mm	q_{\max} mm	F_B N_{\min}
1091	210 B	31,75	9,65	13,95	5,08	10,16	20	13,6	23 000

Verbindungsglieder sind auf Anfrage erhältlich.
Connecting links are available upon request.

Verbindungsglied mit Feder
Connecting link with spring clip

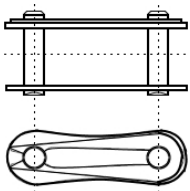

E
Laufichtung
Running direction

Gekröpftes Glied mit Splint
Cranked link with splint pin

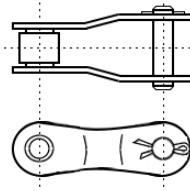

L

Gekröpftes Doppelglied
Cranked double link

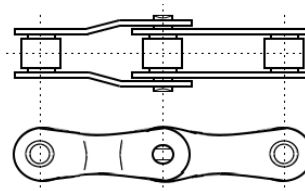

C

Außenglied
Outside link

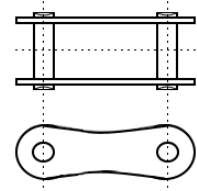

A

Beim Einsatz von gekröpften Gliedern darf nur mit 80% der Bruchkraft gerechnet werden.
When cranked links are used only 80% of the breaking load may be calculated.

LANGGLIEDRIGE FÖRDERKETTEN

DOUBLE PITCH CONVEYOR CHAINS

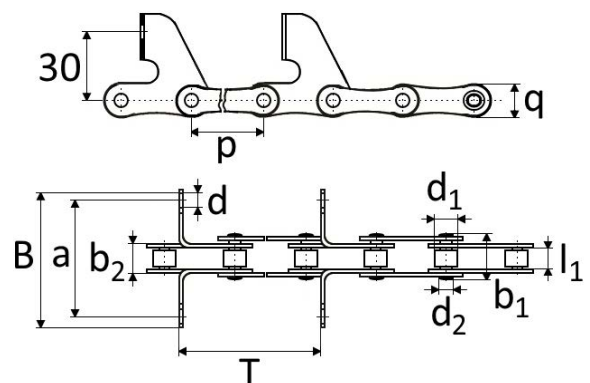
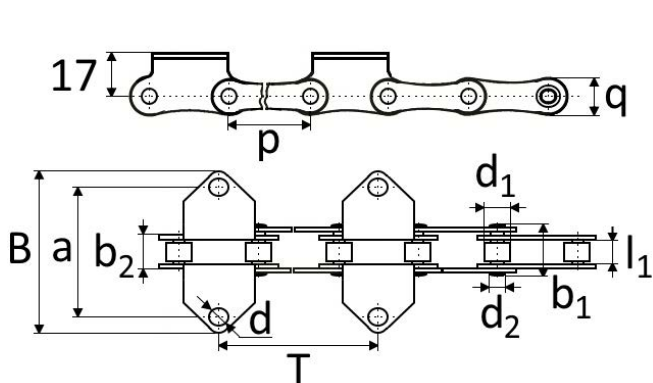

Ketten-Nr. Chain No.	p mm	$b_{1\min}$ mm	$b_{2\max}$ mm	B_{\max} mm	a mm	d mm	$d_{2\min}$ mm	$d_{1\max}$ mm	$l_{1\max}$ mm	q_{\max} mm	T	F_B N_{\min}
1115	31,75	9,65	13,95	72	52	6,6	5,08	10,16	20	13,6	2T; 4T; 6T; 8T; 10T; ...	23 000
1092	31,75	9,65	13,95	72	52	6,6	5,08	10,16	20	13,6	2T; 4T; 6T; 8T; 10T; ...	23 000

ROLLENKETTEN MIT VERGRÖSSERTEM SPIEL

SIDE BOW ROLLER CHAINS

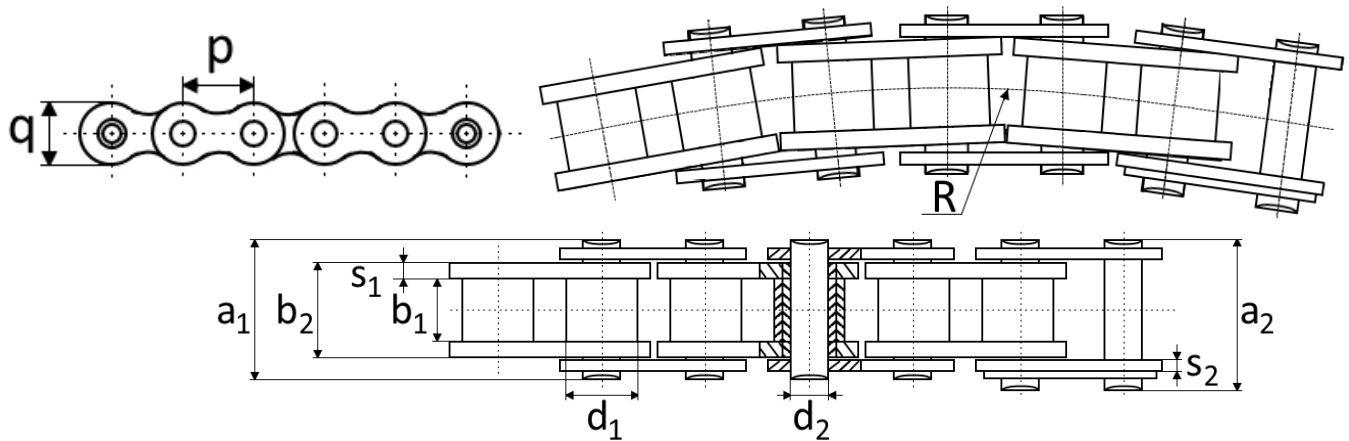

Ketten-Nr. Chain No.	p		R mm	b ₁ mm	b ₂ mm	d ₁ mm	d ₂ mm	a ₁ mm	a ₂ mm	q mm	s ₁ mm	s ₂ mm	F _B N _{min}
	mm	inch											
08B-1 SB	12,7	1/2"	360	7,75	11,3	8,51	3,96	16,4	17,7	11,8	1,5	1,5	11 200
08B-1 SB1	12,7	1/2"	400	11,6	15,35	8,51	3,96	20,8	22	11,8	1,5	1,5	11 200
12B-1 SB	19,05	3/4"	510	11,68	15,62	12,07	5,08	21,8	24,2	16,1	1,8	1,8	20 000
16B-1 SB	25,4	1"	1450	17,02	25,45	15,8	7,94	35,5	38,2	20,3	3,8	3,1	45 000

Verbindungsglieder sind auf Anfrage erhältlich.
Connecting links are available upon request.

LANDMASCHINENKETTEN

AGRICULTURAL CHAINS

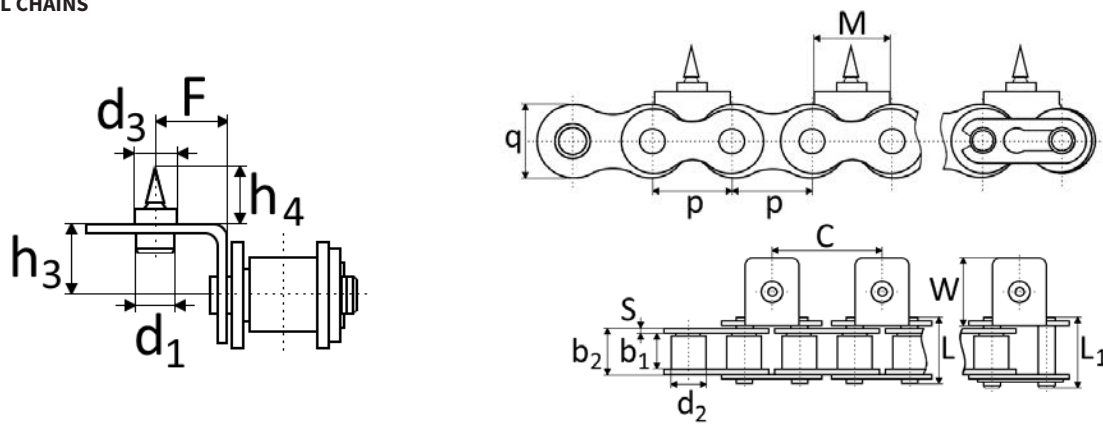

Ketten-Nr. Chain No.	p mm	q mm	d ₁ mm	d ₂ mm	d ₃ mm	b ₁ mm	b ₂ mm	S _{max} mm	c mm	L mm	L ₁ mm	W mm	M mm	h ₃ mm	h ₄ mm	F mm	F _B N _{min}
10B-1 1AKa1.102/432T.00.00	15,875	14,73	5,5	10,16	6	9,65	13,28	1,5	31,75	18,8	20,1	19,55	15,15	10	7,8	9,9	23 000

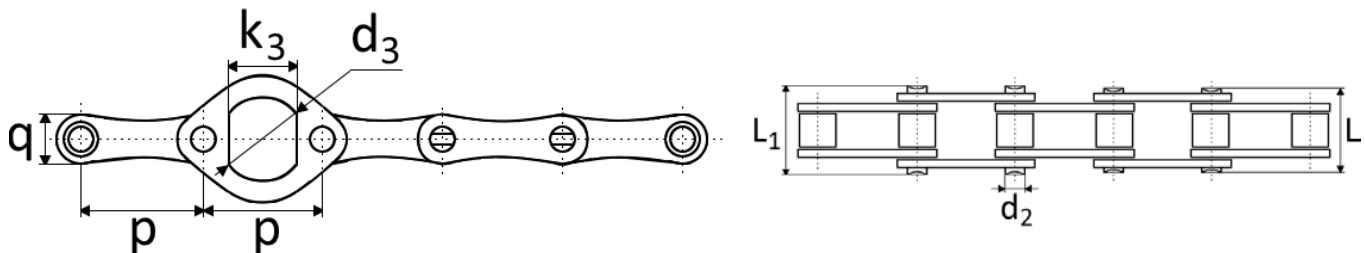

Ketten-Nr. Chain No.	ISO	p mm	k ₃ mm	d ₂ mm	d ₃ mm	L mm	L ₁ mm	q mm	F _B N _{min}
216B.00.00	216 B	50,800	28,3	8,28	35,3	35	40,00	21,08	60 000



ROLLENKETTEN MIT INNENGLIEDERN AUS KUNSTSTOFF

ROLLER CHAINS WITH PLASTIC INNER BLOCKS

UMWELTFREUNDLICH

- Keine Schmierung
- Keine Wartung
- Leicht zu reinigen
- Saubere Vorgehensweise schützt vor der Produktkontamination
- Für den Einsatz in steriler und hygienischer Umgebung
- Gute dielektrische Eigenschaften

HOHE LAUFRUHE

- Um 50% leichter als Stahlketten

PREISGÜNSTIG

- Hohe Dauerfestigkeit
- Geringe Betriebskosten im Vergleich zu Edelstahlketten
- Geeignet für Maschinentechnik mit geringer Zugkraft
- Zusätzliche Anbauteile sind auf Anfrage erhältlich

ANWENDUNGSGEBIETE

- Lebensmittelindustrie
- Verpackungsmaschinen
- Pharmaindustrie
- Elektronikindustrie
- Papierherstellungs- und Bearbeitungsmaschinen
- Medizintechnik

ECOLOGICAL COMPATIBILITY

- Lube Free
- Maintenance free
- Highly cleanable
- Clean operation avoids product contamination
- Sterile or hygienic environments
- Good electrical insulating properties

LOW NOISE

- 50% lighter than steel chains

COST COMPETITIVE

- Long lasting
- Lower cost of operation vs. stainless steel chain
- Low load applications
- Additional attachments are available upon request

FIELDS OF APPLICATION

- Food industry
- Packaging equipment
- Pharmaceutical industry
- Electronics industry
- Paper and cardboard processing machinery
- Medical equipment

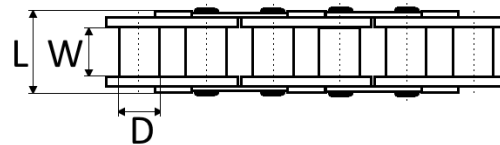
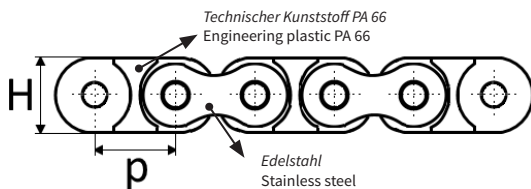

Ketten-Nr. Chain No.	p mm	D mm	W mm	L mm	H mm	F _B N _{min}
RF 06B-1 PL	9,525	6,35	5,72	19	8,26	
RF 08B-1 PL	12,70	8,51	7,75	24	11,81	
RF 10B-1 PL	15,875	10,16	9,65	27	14,73	
RF 12B-1 PL	19,05	11,6	14	26	18,2	3 500



Geschwindigkeit
Speed max. 1 m/s

Druck
Pressure max. 8 N/mm²

Betriebstemperaturen
Temperature range -40 / + 80 °C



ROLLENKETTEN MIT KUNSTSTOFFCLIPS

ROLLER CHAINS WITH PLASTIC CLIPS

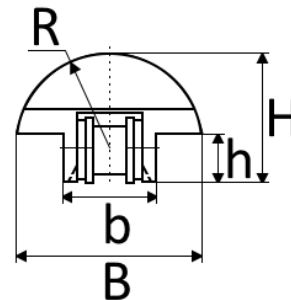
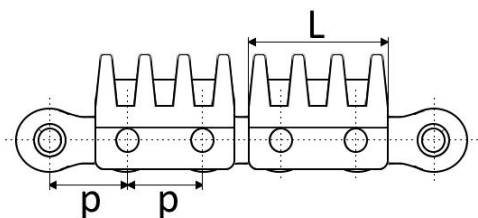

Ketten-Nr. Chain No.	p mm	L mm	b mm	B mm	h mm	H mm	R mm	F _B N _{min}
415 PL1	12,7	23	13,5	27,2	7	19	13,7	10 000



ROLLENKETTEN MIT ANBAUTEILEN AUS KUNSTSTOFF

ROLLER CHAINS WITH PLASTIC ATTACHMENTS

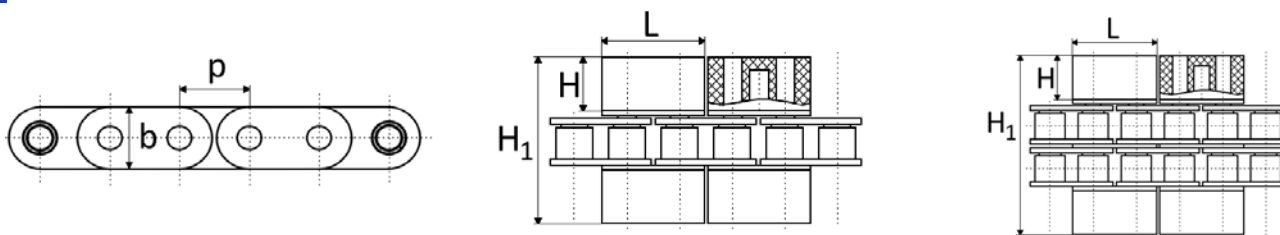

Ketten-Nr. Chain No.	p mm	b mm	L mm	H mm	H ₁ mm	F _B N _{min}
06B-1 GL 2PL1 110EZ 1T	9,525	8,2	17,72	11,4	34,3	9 000
06B-1 GL 2PL101 141EZ 1T	9,525	8,2	17,72	14,3	40	9 000
06B-2 GL 2PL1 112EZ 1T	9,525	8,2	17,72	11,4	44,7	16 900
06B-2 GL 2PL101 143EZ 1T	9,525	8,2	17,72	14,3	50,2	16 900
08B-1 GL PL1 125EZ 1T	12,7	11,8	24,5	12,7	40	18 200
08B-1 GL PL102 95EZ 1T	12,7	11,8	24,5	9,7	34	18 200
08B-1 GL PL103 175EZ 1T	12,7	11,8	24,5	17,7	50	18 200



STAUFÖRDERKETTEN

ACCUMULATION CHAINS

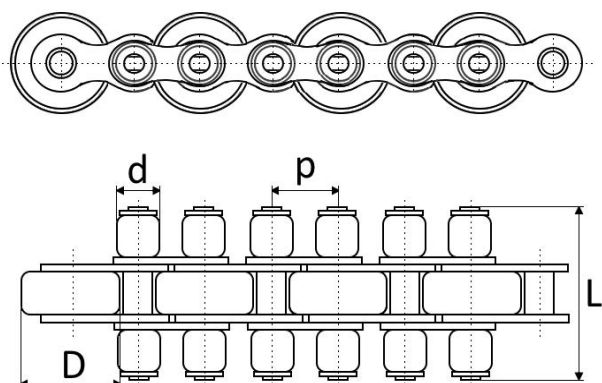

Ketten-Nr. Chain No.	p mm	d mm	D mm	L mm	F _B N _{min}
SFE1 12B-1	19,05	12,07	24	48	28 900
SFE2 12B-1	19,05	12,07	26	48	28 900
SFE3 12B-1	19,05	12,07	28	48	28 900
SFE4 12B-1	19,05	12,07	24	40	28 900
SFE5 12B-1	19,05	12,07	26	43	28 900
SFE7 12B-1	19,05	12,07	28	40	28 900
SFE8 12B-1	19,05	12,07	28	43	28 900
SFE1 16B-1	25,4	15,88	38,5	65	60 000

Kundenspezifische Größen nach Absprache
Dimensions by agreement with the customer

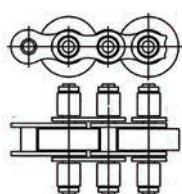

E
mit verlängerten Bolzen
with extended pins

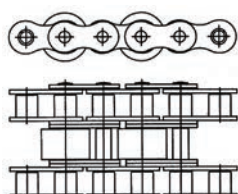

P

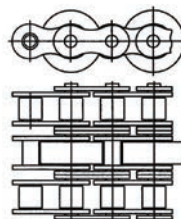

T
Triplex

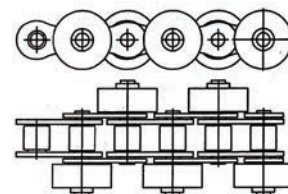

SFE101

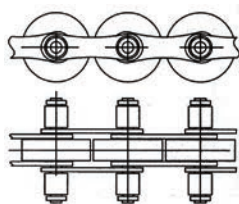

L
Langgliedrige
Long link

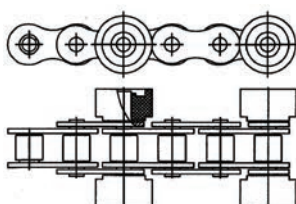

K
mit Anbauteilen aus Kunststoff
with plastic mounts

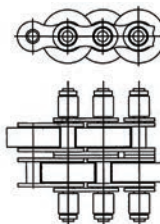

D
Duplex mit versetzten Stauförderrollen
Duplex with offset accumulation rollers





EDELSTAHLKETTEN

STAINLESS STEEL CHAINS

	Ketten-Nr. Chain No.	p		b _{1min} mm	b _{2max} mm	d _{1max} mm	d ₂ mm	l ₁ /l _{2max} mm	q _{max} mm	e mm	F _B N _{min}
		mm	inch								
SIMPLEX	RF 06B-1	9,525	3/8"	5,72	8,53	6,35	3,28	13,15	8,20	-	6 200
	RF 08B-1	12,7	1/2"	7,75	11,3	8,51	4,45	17	11,8	-	11 500
	RF 10B-1	15,88	5/8"	9,65	13,28	10,16	5,08	18,8	14,73	-	14 500
	RF 12B-1	19,05	3/4"	11,68	15,62	12,07	5,72	21,8	16,1	-	18 500
	RF 16B-1	25,400	1"	17,02	25,45	15,88	8,28	36,10	21,00	-	40 000
DUPEX	RF 08B-2	12,70	1/2"	7,75	11,3	8,51	4,45	31,20	11,80		16 000
	RF 10B-2	15,875	5/8"	9,65	13,28	10,16	5,08	36,10	14,70		22 250
	RF 12B-2	19,050	3/4"	11,68	15,62	12,07	5,72	42,00	16,00		28 900
	RF 16B-2	25,40	1"	17,02	25,45	15,88	8,28	68,0	21,00		53 000

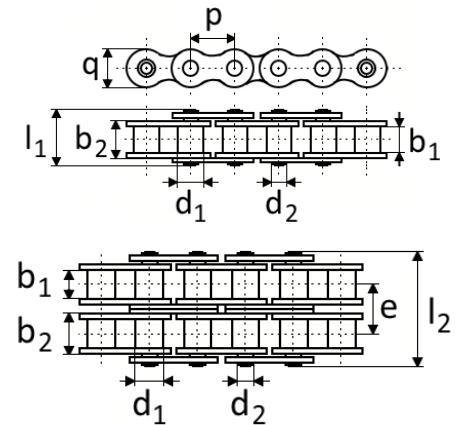

Typ Type	Ketten-Nr. Chain No.	Index	p mm	l mm	h mm	h ₂ mm	H mm	S mm	d mm	f mm	F mm
MIT PLANLASCHEN STRAIGHT ATTACHMENTS	RF 08B-1 1M1 RF 08B-1 2M1	102	12,7	13	14,2	-	20	1,3	4,2	-	-
	RF 10B-1 1M1 RF 10B-1 2M1	102	15,875	15,15	17	-	26,8	1,5	5,3	-	-
	RF 12B-1 1M1 RF 12B-1 2M1	102	19,05	18	18,2	-	26	1,8	6	-	-
MIT WINKELASCHEN BENT ATTACHMENTS	RF 08B-1 1K1 RF 08B-1 2K1	102	12,7	13	-	10	-	1,3	4,2	24,8	36,9
	RF 10B-1 1K1 RF 10B-1 2K1	102	15,875	15,15	-	10	-	1,5	5,3	33,2	52,5
	RF 12B-1 1K1 RF 12B-1 2K1	102	19,05	18	-	12,2	-	1,8	6	35	50,6

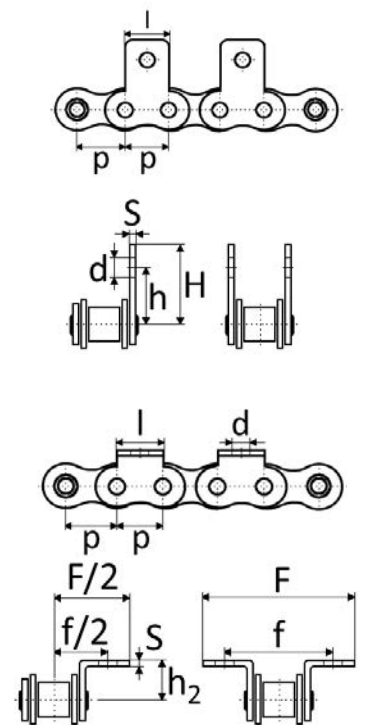

VERZINKTE UND VERNICKELTE ROLLENKETTEN

NICKEL AND ZINC PLATED CHAINS



Vernickelte Rollenketten
Nickel-plated chains



Verzinkte Rollenketten
Zinc-plated chains

Alle Rollenketten der METEOR Kettenfabrik GmbH sind auf Anfrage in verzinkter oder vernickelter Ausführung erhältlich. Die Beschichtung der Rollenketten mit Nickel oder Zink sichert den perfekten Schutz vor Korrosion, d. h. ermöglicht ihre Anwendung in Salzlösungen, korrosiver Umgebung, sowie auch an Orten mit hoher Luftfeuchtigkeit. Der Überzug wird auf den unterschiedlichen Ketten gemäß ISO/DIN und ANSI Normen ausgeführt. Solche Ketten sind geeignet für die Lebensmittelindustrie, die Textilindustrie und weitere Branchen, wo Sauberkeitsanforderungen besonders hoch sind.

All roller chains of METEOR Kettenfabrik Ltd. are available upon request with nickel or zinc plating. The chains with nickel- or zinc-coat are perfectly safe from rusting and therefore could be applied with salting liquids, corrosive environments and under the higher humidity conditions. Manufactured according to ISO/DIN and ANSI standards plating is possible for a different kind of chains. These chains are featured for the food processing industry and the fabric industry application, as well branches with especially high cleanliness requirements.

LEISTUNGSFÄHIG

Beim vorschriftmäßigen Einsatz besteht ein Wirkungsgrad bis 98 %.

VIELSEITIG

Rollenketten werden vorwiegend als Antriebselemente zur Kraftübertragung zwischen parallelen Wellen, weniger als Lastketten, verwendet. Spezialanbauglieder ermöglichen den Einsatz als Transport- und Förderketten. Rollenkettengetriebe sind geeignet für unterschiedlichste Achsabstände, Geschwindigkeiten und Belastungen.

Durch die Symmetrie der Rollenkette ist es möglich, dass sie im Rechts- und Linkslauf betrieben werden kann.

DAUERHAFT

Bei richtiger Dimensionierung der Kette, exakter Montage des Kettengetriebes und Einhaltung der vorgeschriebenen Schmierung erreichen Rollenketten eine Lebensdauer von bis zu 15.000 Betriebsstunden.

ELASTISCH

Durch das elastische Verhalten der Rollenketten können von Rollenkettengetrieben im Vergleich zu anderen Getrieben bedeutend größere Stoßbelastungen aufgenommen werden.

WIRTSCHAFTLICH

Geringe Herstellungskosten, günstige Nutzung des Bauraumes, einfache Montage, Wartung und Instandhaltung gewährleisten die große Wirtschaftlichkeit eines Rollenkettengetriebes.

PFLEGE & WARTUNG

Die vorgesehene Lebensdauer der Rollenketten wird nur durch eine regelmäßige Pflege und Wartung erreicht. Pflege- und Wartungsintervalle sind je nach Anwendung und Verschmutzungsgrad recht unterschiedlich. Es sollte darauf geachtet werden, dass Schmieröl entsprechend den Schmiermittelempfehlungen verwendet wird. Die Rollenkette muss regelmäßig auf ihre Abnutzung untersucht werden. Beschädigte Kettenglieder oder verschlissene Kettenräder sind auszuwechseln!

FESTIGKEIT & VERSCHLEISS

In DIN 8187 und 8188 sind für die einzelnen Rollenketten die standardisierten Mindestbruchkräfte angegeben, die eine Aussage über die maximalen Kettenbelastungen ermöglichen. Eine exakte Dimensionierung der Rollenketten erfolgt nach ihrer übertragbaren Leistung, die in Abhängigkeit von der Drehzahl des kleineren Kettenrades diagrammatisch in DIN 8195 dargestellt ist. Korrekturfaktoren berücksichtigen die unterschiedlichsten Betriebsbedingungen. Beim Betreiben eines Kettengetriebes unterliegt die Rollenkette einem Verschleiß. Während der Herstellung der Kette wird diese zu erwartenden Abnutzung durch die optimale Auswahl der Werkstoffe, die adäquate Oberflächenbeschaffenheit der Einzelteile und einer entsprechenden Wärmebehandlung entgegengewirkt. Entscheidenden Einfluss auf die Verschleiß- und Dauerfestigkeit haben neben der Verwendung hochwertiger Werkstoffe, eine exakte Wärmebehandlung und die Herstellung der Einzelteile sowie die Montage der Rollenketten in engen Toleranzbereichen.

SCHMIERUNG

Die Rollenketten brauchen, um die Leistungsparameter zu erfüllen, eine geeignete Schmierung. Das Schmiermittel muss stets Bolzen und Buchse (Gelenke) sowie die Rolle erreichen. Beim Aufschlagen der Rolle auf die Zähne der Kettenräder mindert das Schmiermittel entscheidend die Stöße. Die dämpfend wirkende Funktion des Schmiermittels erhöht die Elastizität, verhindert unnötigen Verschleiß und wirkt gleichzeitig geräuschmindernd. Trockenlauf von Rollenketten führt zu einer abnormalen Längung in kürzester Zeit, sodass die Kette unbrauchbar wird.

EFFICIENT

When used in compliance with application instructions the degree of efficiency is up to 98%.

VERSATILE

Roller chains are primarily used as drive elements for power transmission between parallel shafts and rare as load-bearing chains. Special attachment links may be used as transport and conveyor chains. Roller chain drives are applicable by different axle distances, speeds and loads. The roller chain can be operated in a clockwise and counter-clockwise direction due to its symmetrical design.

DURABLE

When chains are dimensioned properly, the chain drive is exactly installed and the required lubrication is applied, the service life of roller chains reaches up to 15.000 operating hours.

ELASTIC

In comparison to other drives, roller chain drives can bear significantly higher impact loads because of the elastic properties of roller chains.

COST-EFFICIENT

Low production cost, favorable space utilization, simple installation, service and maintenance guarantee the great economy of a roller chain drive.

SERVICE AND MAINTENANCE

The intended service life of the roller chains may be achieved only with regular service and maintenance. The service and maintenance cycles vary greatly from application and degree of contamination. Lubricating oils should be used in accordance with the lubricant recommendations. The roller chain must be regularly inspected for wear. Damaged chain links or worn sprockets must be replaced!

STRENGTH & WEAR

Standard minimum breaking strengths specified in DIN 8187 and 8188 for separate roller chains allow to determine the maximum chain loads. Exact dimensioning of the roller chains is based on its transmitted power which is represented diagrammatically in relation to the rotational speed of the smaller sprocket due to DIN 8195. There should be taken into account various operating conditions by adjusting. When chain drive is operating, the roller chain is subject to wear. During the production of the chain, this wear is counteracted by the optimum selection of the raw stuff, adequate surface properties of the component parts and respective heat treatment. Apart from the use of high-quality raw materials, a decisive impact on the wear resistance and fatigue strength is achieved by proper heat treatment, production cycle of component parts as well as by roller chain installation resulting a very tight tolerance.

LUBRICATION

The roller chains require suitable lubrication to meet its performance parameters. The lubricant must always reach pin and bush (joints) as well as the roller. When the roller strikes sprocket's teeth, the lubricant reduces the impact significantly. The absorbing function of the lubricant increases the elasticity, prevents unnecessary wear and has a sound-absorbing effect at the same time. Dry-run of roller chains leads to abnormal lengthening in a very short time, so the chain become unusable.

SCHMIERMITTEL

Als Schmierstoff für Rollenketten werden Spezi­alschmiermit­tel verwendet, die den in der Praxis geläufigen Schmie­rungsarten wie Handschmierung, Tropfschmierung, Tauchschmierung im Ölbad, Druckumlaufschmierung, Sprühschmierung gerecht werden. Die Wahl der Schmie­rungsart ist abhängig von der zu übertragenden Leistung, der Kettengeschwindigkeit und den Einsatzbedingungen. Für Anwender ist die sorgfältige Einhaltung der Schmie­rungs­vorschriften und Schmie­rungsintervalle für eine hohe Lebensdauer der Rollenketten von ausschlaggebender Bedeutung.

KONSERVIERUNG UND ERSTSCHMIERUNG DER METEOR-ROLLENKETTEN

Neben der Standardschmierung, die gleichzeitig als Erstschi­erung dient, besteht die Möglichkeit durch einen Aufpreis, die METEOR-Rollenketten mit einem Sonderschmiermittel dem Kundenwunsch und folgenden Einsatzbedingungen entsprechend zu versehen:

1. staub-schmutz-oder flusenhaltige Umgebung
2. als Langzeit-Schmierung gegen Feuchtigkeit und Nässe oder zur Geräuschdämmung
3. Lebensmittelindustrie (UH1-Zulassung)
4. Tieftemperaturbereich
5. Hochtemperaturbereich
6. Kraftfahrzeugindustrie für Lacktrockner
7. Land- und Forstwirtschaft, Fahrtreppenkettenöl

MONTAGE VON ROLLENKETTENGETRIEBEN

Die Lebensdauer der Rollenkette ist zum größten Teil abhängig vom exakten Fluchten der Kettenräder, der Achsparallelität der Wellen und des schlagfreien Laufes der Kettenräder. Der Durchhang des Leertrums soll bei horizontaler Anordnung des Getriebes maximal 1 - 2 % des Achsabstandes betragen.

KETTENRÄDER

Für die Lebensdauer einer Rollenkette ist die richtige Radkonstruktion und Verzahnung entscheidend. Die gebräuchlichsten Ausführungsformen für Einfach- und Mehrfachrollenketten sind:

- A = Kettenradscheibe
- B = Kettenrad mit einseitiger Nabe
- C = Kettenrad mit beidseitiger Nabe (symmetrisch und asymmetrisch)

Bei Anfragen und Bestellungen sind mindestens folgende Angaben erforderlich:

- Ausführung des Kettenrades
- Ketten-Nr.
- z = Zähnezahl
- d = Teilkreis Ø
- dn = Naben Ø
- db = Bohrung mit Passung (Nut und Stellschraube bei Bedarf)
- n = Nabelänge
- B1 = Zahnbreite
- Werkstoff, gegebenenfalls Wärmebehandlung.

Der Werkstoff für Kettenräder muss für das entsprechende Einsatzgebiet richtig gewählt werden. Kleine Kettenräder werden in den meisten Fällen aus unlegiertem Stahl mit einer Festigkeit von 600 - 700 N/mm² (St60, C45 u. a.) hergestellt. Bei Antriebsritzel mit Drehzahl über 500 U/min oder bei Kettengeschwindigkeiten über 7 m/s ist eine Vergütung der Zähne auf ca. 50 HRC empfehlenswert. Für größere Räder reicht bei normaler Belastung in der Regel Gusseisen aus. Bei höheren Belastungen sind Stahlguss oder eine Stahlschweißkonstruktion angebracht.

Sollten Sie weiterführende Fragen haben, so verweisen wir Sie an entsprechende Fachleute unseres Unternehmens.

LUBRICANTS

There are used special oils as lubricants for roller chains that comply with the commonly used conservation types such as manual, drip, oil bath, forced-feed and spray lubrication. The choice of lubrication type depends on the power to be transferred, the chain speed and operating conditions. The careful application of the lubrication requirements and cycles is critical for the user to ensure high service life of roller chains.

CONSERVATION AND INITIAL LUBRICATION OF METEOR-ROLLER CHAINS

Apart from the standard conservation, which is the initial lubrication at the same, there is a chance at extra charge to cover METEOR-Roller chains with some specific oil due to customer desire and operating condition as follows:

1. *dust-contaminated or lint-containing environment*
2. *as long-term conservation against humidity and moisture or for the noise insulation*
3. *food industry (UH1-licence)*
4. *low temperature range*
5. *high temperature range*
6. *car industry for varnish dryer*
7. *lubricant for escalator chain in agriculture and forestry*

INSTALLATION OF ROLLER CHAIN DRIVES

The service life of the roller chain depends primarily on the axial parallelism of the shafts, the exact alignment and free run of sprockets. The slack of the loose side at horizontal arrangement of the drive should not exceed 1-2% of the axle spacing.

SPROCKETS

For the service life of a roller chain the correct wheel design and tooth-ing is critical. The most common design types both for single and multiple strand roller chains are:

- A = plate sprocket*
- B = sprocket with one-sided hub*
- C = sprocket with double-sided hub (symmetrical and asymmetrical)*

For inquiries and orders at least the following specifications are necessary:

- Type of the sprocket*
- Chain-No.*
- z = number of teeth*
- d = pitch circle Ø*
- dn = hub Ø*
- db = boring with fitting (key and set screw if required)*
- n = hub length*
- B1 = tooth width*
- Material; if needed, heat treatment*

The raw stuff for sprockets should be chosen appropriate due to operating conditions. Small sprockets are usually manufactured of plain carbon-steel with a tensile strength of 600 - 700 N/mm² (St60, C45, and others). For driving pinions with a speed higher than 500 rpm or with chain speed higher than 7 m/sec a tempering of the teeth to approx. 50 HRC is recommended. For larger sprockets at normal loads cast iron is usually sufficient. For higher stresses steel casting or a welded steel construction is appropriate.

For further questions, please consult the respective specialist of our company.

1 Eingebaute Ketten im Endloszustand, also inkl. Verschlussglied, sollten wenn möglich eine gerade Gliederzahl aufweisen, damit kein gekröpftes Glied (Bruchkraftreduktion um 20%) eingebaut werden muss.

Installed endless chains, including connecting link, should, if possible, always have an even number of links, so no cranked link need to be used (Breaking load is 20% less).

2 Offene, abgelängte Ketten haben immer eine ungerade Gliederzahl. Um die Montage zu erleichtern, verwendet man für Endlosketten möglichst lösbare Verschlussglieder.

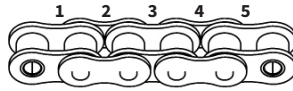

Open cut to length chains, should always have an uneven number of links. For ease of mounting, detachable connecting links are to be used.

Bei Verschlussgliedern "E" soll die geschlossene Seite der Feder in Laufrichtung sein.



With connecting link type "E", the closed end of the spring clip is to look in the running direction.

3 Bei Bestellung von Ketten in Gliederzahl ist zusätzlich mitzuteilen, ob die Gliederzahl inkl. oder ohne Verschlussglied zu verstehen ist.

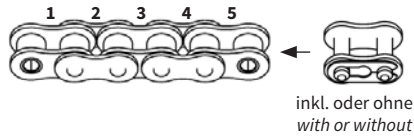

When chains are ordered by number of links, please notify whether the number of links is with or without the connecting link.

4 Bei Bestellung von Ketten per Meter wird immer eine ungerade Gliederzahl geliefert. Die Lieferlänge entspricht der Bestelllänge, die auf die nächste ungerade Gliederzahl aufgerundet wird. Die richtige Verschlussgliederkombination ist vom Kunden zu bestimmen, um die benötigte Endloslänge zu erhalten.

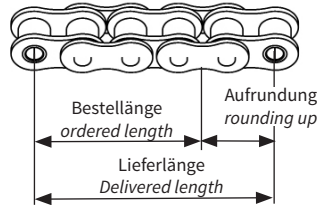

When chains are ordered by meter, an uneven number of links will be delivered. The delivered chain length is the ordered length rounded up to the next uneven number of links. The appropriate combination of connecting links is to be appointed by the customer to get the correct length needed.

5 Verschlusskombinationen

Gerade Gliederzahl inkl. Verschlussglied
Even number of links incl. connecting link

Connection combinations

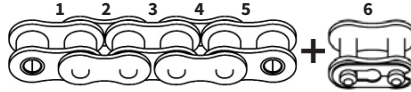

Ungerade Gliederzahl inkl. Verschlussglied je nach Kettentyp:
Uneven number of links incl. connecting link due to chain type:

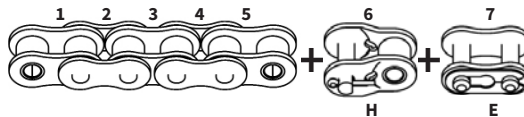
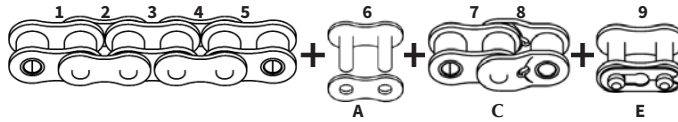

Zoll (") in mm						Engl. Fuß (ft) in cm		PS in kW		3kW in PS	
Zoll		mm	Zoll		mm	Fuß	cm	PS	kW	kW	PS
$\frac{1}{32}$	0,031	0,794	$\frac{13}{16}$	0,812	20,637	1,0	30,5	1,0	0,73	1,0	1,36
$\frac{1}{16}$	0,062	1,587	$\frac{27}{32}$	0,844	21,431	1,1	33,5	1,5	1,10	1,5	2,04
$\frac{3}{32}$	0,094	2,381	$\frac{7}{8}$	0,875	22,225	1,2	36,6	2,0	1,47	2,0	2,72
$\frac{1}{8}$	0,125	3,175	$2\frac{9}{32}$	0,906	23,019	1,3	39,6	2,5	1,83	2,5	3,4
$\frac{5}{32}$	0,156	3,969	$1\frac{5}{16}$	0,937	23,812	1,4	42,7	3,0	2,20	3,0	4,08
$\frac{3}{16}$	0,187	4,762	$3\frac{1}{32}$	0,969	24,606	1,5	45,7	3,5	2,57	3,5	4,76
$\frac{7}{32}$	0,219	5,556	1	1	25,4	1,6	48,8	4,0	2,94	4,0	5,44
$\frac{1}{4}$	0,25	6,35	$1\frac{1}{32}$	1,031	26,194	1,7	51,8	5,0	3,67	5,0	6,8
$\frac{9}{32}$	0,281	7,144	$1\frac{1}{16}$	1,062	26,987	1,8	54,9	6,0	4,41	6,0	8,16
$\frac{5}{16}$	0,312	7,937	$1\frac{3}{32}$	1,094	27,781	1,9	57,9	7,0	5,14	7,0	9,52
$\frac{11}{32}$	0,344	8,731	$1\frac{1}{8}$	1,125	28,575	2,0	61,0	8,0	5,83	8,0	10,88
$\frac{3}{8}$	0,375	9,525	$1\frac{5}{32}$	1,156	29,369	2,5	76,2	9,0	6,61	9,0	12,24
$\frac{13}{32}$	0,406	10,319	$1\frac{3}{16}$	1,187	30,162	3,0	91,4	10,0	7,35	10,0	13,6
$\frac{7}{16}$	0,437	11,112	$1\frac{7}{32}$	1,219	30,956	3,5	106,7	11,0	8,09	11,0	14,96
$\frac{15}{32}$	0,469	11,906	$1\frac{1}{4}$	1,25	31,75	4,0	121,9	12,0	8,82	12,0	16,32
$\frac{1}{2}$	0,5	12,7	$1\frac{9}{32}$	1,281	32,544	4,5	137,2	13,0	9,56	13,0	17,68
$\frac{17}{32}$	0,531	13,494	$1\frac{5}{16}$	1,312	33,337	5,0	152,4	14,0	10,30	14,0	19,04
$\frac{9}{16}$	0,562	14,287	$1\frac{11}{32}$	1,344	34,131	10,0	304,8	15,0	11,03	15,0	20,04
$\frac{19}{32}$	0,594	15,081	$1\frac{3}{8}$	1,375	34,925	15,0	457,2	16,0	11,76	16,0	21,76
$\frac{5}{8}$	0,625	15,875	$1\frac{13}{32}$	1,406	35,719	20,0	609,6	17,0	12,5	17,0	23,12
$\frac{21}{32}$	0,656	16,669	$1\frac{7}{16}$	1,437	36,512	25,0	762,0	18,0	13,23	18,0	24,48
$\frac{11}{16}$	0,687	17,462	$1\frac{15}{32}$	1,469	37,306	30,0	914,4	19,0	13,97	19,0	25,84
$\frac{23}{32}$	0,719	18,256	$1\frac{1}{2}$	1,5	38,1	35,0	1066,8	20,0	14,70	20,0	27,2
$\frac{3}{4}$	0,75	19,05	$1\frac{3}{4}$	1,75	44,45	40,0	1219,2	25,0	18,38	25,0	34,0
$\frac{25}{32}$	0,781	19,844	2	2	50,8	50,0	1524,0	50,0	36,76	50,0	68,0

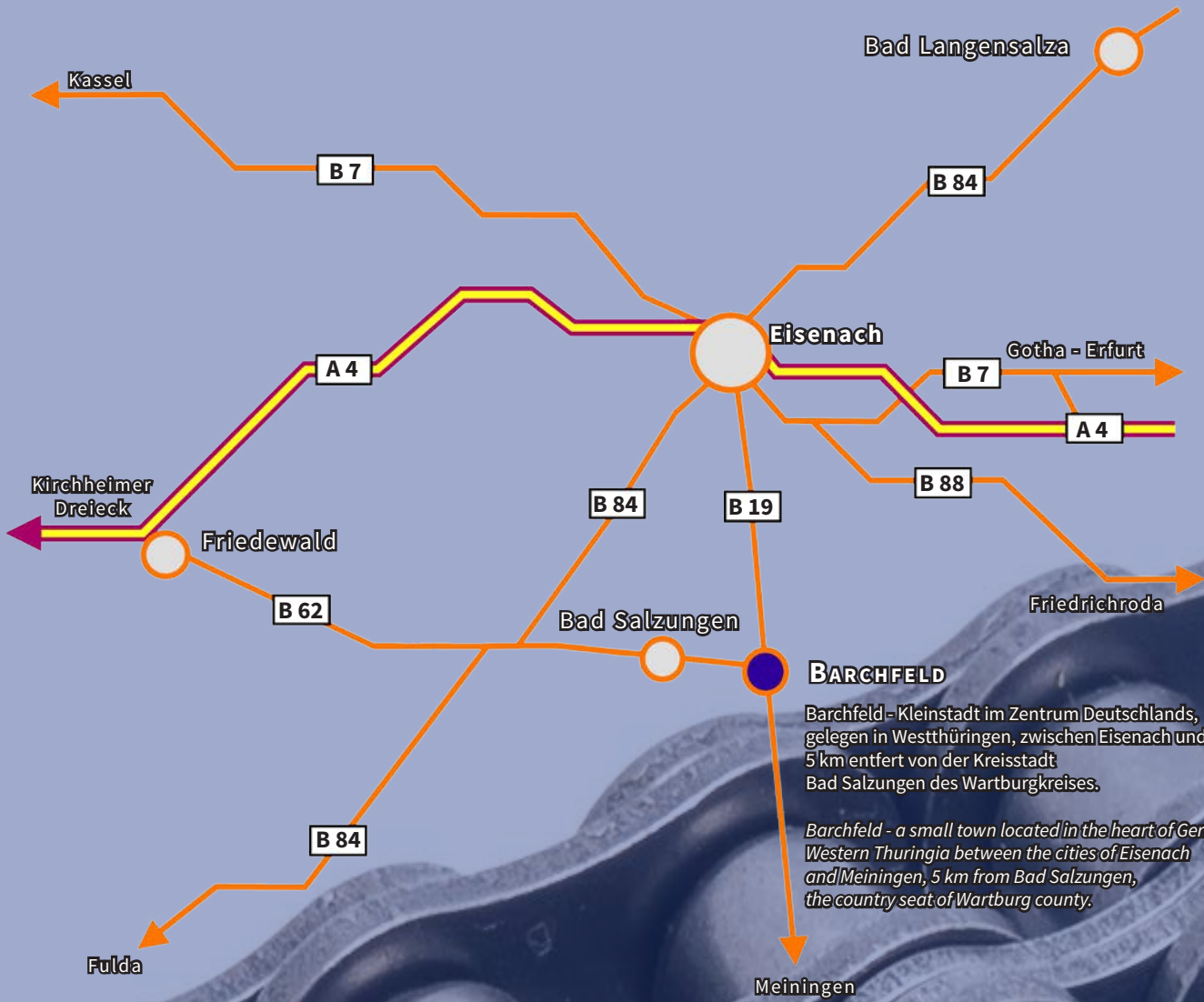

BARCHFELD

Barchfeld - Kleinstadt im Zentrum Deutschlands, gelegen in Westthüringen, zwischen Eisenach und Meiningen, 5 km entfernt von der Kreisstadt Bad Salzungen des Wartburgkreises.

Barchfeld - a small town located in the heart of Germany in Western Thuringia between the cities of Eisenach and Meiningen, 5 km from Bad Salzungen, the county seat of Wartburg county.

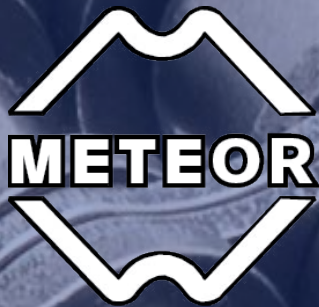

METEOR Kettenfabrik GmbH

Nürnberger Straße 2
36456 Barchfeld/Werra
Deutschland

Tel.: +49 (0)36961/69 04-0
Fax: +49 (0)36961/69 04-29

info@meteor-ketten.com
www.meteor-ketten.com



METEOR Kettenfabrik GmbH

www.meteor-ketten.com

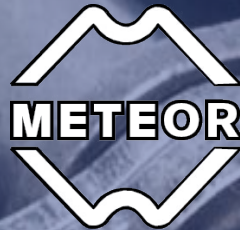

Deutsche Qualität seit 1892